

# USE AND MAINTENANCE MANUAL

 **FIMAP®**



iMx 50B  
iMx 50BT  
iMx 50BB

ED. 05-2013

EN

ORIGINAL  
INSTRUCTIONS  
Doc. 10042009  
Ver. AA



---

The descriptions contained in this document are not binding.

The company therefore reserves the right to make any modifications at any time to elements, details, or accessory supply, as considered necessary for reasons of improvement or manufacturing/commercial requirements.

The reproduction, even partial, of the text and drawings contained in this document is prohibited by law.

---

The company reserves the right to make any technical and/or supply modifications. The images are for reference purposes only, and are not binding in terms of design and supply.

---

### Symbols used in the manual

---



Open book symbol with an "i"  
Indicates the need to consult the instruction manual

---

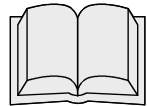

Open book symbol  
Used to tell the operator to read the manual before using the machine

---



Warning symbol  
Carefully read the sections marked with this symbol and observe the indications, for the safety of the operator and the machine

---



Warning symbol  
Indicates danger of gas exhalation and leakage of corrosive liquids

---



Warning symbol  
Indicates operator should take safety measures to avoid damage to limbs.

---



Warning symbol  
Indicates the danger of fire.  
Do not go near with free flames

---



Warning symbol  
Indicates that the packed product should be handled with suitable lifting means that comply with the legal requirements

---



Disposal symbol  
Carefully read the sections marked with this symbol for machine disposal

---



## CONTENTS

<b>ON CONSIGNMENT OF THE MACHINE</b> .....	5
<b>INTENDED USE</b> .....	5
<b>INTRODUCTORY COMMENT</b> .....	5
<b>SERIAL NUMBER PLATE</b> .....	5
<b>TECHNICAL DESCRIPTION</b> .....	5
<b>SYMBOLS USED ON THE MACHINE</b> .....	6
<b>GENERAL SAFETY REGULATIONS</b> .....	9
<b>MACHINE PREPARATION</b> .....	10
1. HANDLING OF THE PACKED MACHINE .....	10
2. HOW TO MOVE THE MACHINE .....	11
3. FRONT MACHINE COMPONENTS.....	11
4. SIDE COMPONENTS OF THE MACHINE .....	11
5. REAR COMPONENTS OF THE MACHINE.....	11
6. CONTROL PANEL COMPONENTS (VERSION B) .....	12
7. CONTROL PANEL COMPONENTS (VERSION BT).....	12
8. CONTROL PANEL COMPONENTS (VERSION BB).....	13
9. TYPE OF BATTERY.....	13
10. BATTERY MAINTENANCE AND DISPOSAL .....	14
11. HANDLING - INSERTING BATTERIES .....	14
12. CONNECTING THE BATTERIES AND BATTERY CONNECTOR.....	16
13. CONNECTING THE BATTERY CHARGER (VERSIONS WITHOUT BC) .....	16
14. CONNECTING THE BATTERY CHARGER (VERSIONS WITH BC) .....	18
15. BATTERY CHARGE LEVEL INDICATOR (B-BT VERSIONS) .....	19
16. HOUR METER (B-BT VERSIONS) .....	19
17. BATTERY CHARGE LEVEL INDICATOR (BB VERSIONS) .....	19
18. FORWARD WORK SPEED (BT VERSIONS).....	20
19. FORWARD WORK SPEED (B-BB VERSIONS).....	20
20. FILLING THE SOLUTION TANK.....	20
21. ASSEMBLING THE SQUEEGEE.....	21
22. ASSEMBLING THE BRUSH (B-BT VERSIONS) .....	22
23. ASSEMBLING THE BRUSH (BB VERSIONS) .....	22
24. TRANSPORTATION MODE.....	22
<b>WORK</b> .....	23
25. PREPARING TO WORK (B-BT VERSIONS).....	23
26. PREPARING TO WORK (BB VERSIONS) .....	25
27. REGULATING THE DETERGENT (B VERSION).....	26
28. REGULATING THE DETERGENT (BT VERSION) .....	27
29. REGULATING THE DETERGENT (BB VERSION) .....	27
30. ADJUSTING THE FORWARD WORKING SPEED (BT VERSIONS).....	28
31. REVERSE FUNCTION (BT VERSIONS).....	28
32. "ECO" DEVICE (B-BT VERSIONS).....	28
33. OVERFLOW DEVICE (B-BT VERSIONS) .....	29
34. OVERFLOW DEVICE (BB VERSIONS).....	30
35. EMPTYING THE RECOVERY TANK (B-BT VERSIONS) .....	30
36. EMPTYING THE RECOVERY TANK (BB VERSIONS).....	30
<b>AT THE END OF WORK</b> .....	31
37. AT THE END OF WORK (B-BT VERSIONS).....	31
38. AT THE END OF WORK (BB VERSIONS) .....	33
<b>DAILY MAINTENANCE</b> .....	35
39. CLEANING THE SOLUTION TANK FILTER - CAP.....	35
40. CLEANING THE RECOVERY TANK FILTER.....	35
41. CLEANING THE BRUSH (B-BT VERSIONS) .....	36
42. CLEANING THE BRUSH (BB VERSIONS) .....	37
43. CLEANING THE SQUEEGEE BODY .....	37



---

<b>WEEKLY MAINTENANCE</b> .....	<b>39</b>
44. CLEANING THE VACUUM HOSE .....	39
45. CLEANING THE RECOVERY TANK .....	39
46. CLEANING THE SOLUTION TANK .....	41
<b>EMERGENCY MAINTENANCE</b> .....	<b>42</b>
47. ADJUSTING THE PARKING BRAKE (ONLY FOR BT VERSIONS) .....	42
48. BRUSH REPLACEMENT (B-BT VERSIONS).....	42
49. BRUSH REPLACEMENT (BB VERSIONS) .....	42
50. REGULATING MACHINE DIRECTION.....	43
51. REPLACING SQUEEGEE BODY RUBBERS.....	43
52. ADJUSTING THE SQUEEGEE INCLINATION.....	44
53. ADJUSTING THE SQUEEGEE HEIGHT .....	44
<b>TROUBLESHOOTING</b> .....	<b>45</b>
54. THE MACHINE DOES NOT START .....	45
55. INSUFFICIENT WATER ON THE BRUSHES.....	45
56. THE SQUEEGEE DOES NOT DRY PERFECTLY .....	45
57. THE MACHINE DOES NOT CLEAN WELL .....	45
58. EXCESSIVE FOAM PRODUCTION .....	45
59. THE VACUUM CLEANER DOES NOT FUNCTION .....	45
60. THE BRUSH MOTOR DOES NOT WORK .....	45
<b>DISPOSAL</b> .....	<b>46</b>
<b>CHOOSING AND USING THE BRUSHES</b> .....	<b>47</b>
<b>EC DECLARATION OF CONFORMITY</b> .....	<b>48</b>



### On consignment of the machine

When the machine is consigned to the customer, an immediate check must be performed to ensure all the material mentioned in the shipping documents has been received, and also to check the machine has not suffered damage during transportation. If this is the case, the carrier must ascertain the extent of the damage at once, informing our customer service office. It is only by prompt action of this type that the missing material can be obtained, and compensation for damage successfully claimed.

### Introductory comment

The iMx is a floor scrubbing machine which, by means of the mechanical action of the rotating brush and the chemical action of a water/detergent solution, can clean any type of flooring. As it advances, it also collects any removed dirt as well as the detergent solution not absorbed by the floor.

**The machine must only be used for this purpose.** Even the best machines will only work well if used correctly and kept in good working order. We therefore suggest you read this instruction booklet carefully and read it again whenever difficulties arise while using the machine. If necessary, remember that our customer assistance service (organised in collaboration with our dealers) is always available for advice or direct intervention.

### Intended use

The floor scrubbing machine is designed exclusively for the professional cleaning of surfaces and floors in industrial, commercial and public environments. The machine is only suitable for use in closed - or at least covered - locations.

The machine is not suitable for use in the rain, or under water jets. It is FORBIDDEN to use the machine for picking up dangerous dusts or inflammable liquids within places with a potentially explosive atmosphere. In addition, it is not suitable as a means of transport for people or objects.

### Serial number plate

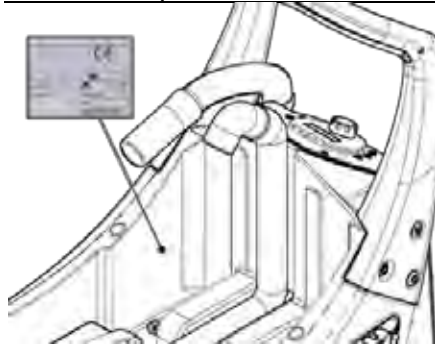

TECHNICAL DESCRIPTION	UM	iMx 50B	iMx 50BT	iMx 50BB
Working width	mm	508	508	508
Squeegee width	mm	705	705	705
Working capacity, up to	m <sup>2</sup> /h	2032	2032	2032
Disc brush	No. / $\varnothing$ mm	1 / 508	1 / 508	1 / 508
Disc brush rotations	rpm	166	166	166
Brush motor	V/W	24 / 500	24 / 500	24 / 500
Maximum pressure on the brush	kg	25	25	25
Traction motor	V/W	-	24 / 150	-
Traction wheel (number / diameter / width)	No. / ( $\varnothing$ mm / mm)	2 / (225 / 64)	2 / (225 / 64)	2 / (172.5 / 45)
Maximum forward speed in transport mode	km/h	-	4	-
Maximum forward speed in working mode	km/h	-	3.9	-
Maximum gradient with full load	%	2	2	2
Vacuum motor	No./V/W	1 / (24 / 310)	1 / (24 / 310)	1 / (24 / 310)
Suction vacuum	mmH <sub>2</sub> O	610	610	610
Rear wheel (number / diameter / width)	$\varnothing$ mm / mm	1 / 80 / 23	1 / 80 / 23	1 / 80 / 23
Solution tank	l	41	41	41
Recovery tank	l	37	37	37
Steering diameter	mm	850	850	850
Machine length	mm	1180	1180	1180
Machine length (with splash guard kit)	mm	1200	1200	1200
Machine height	mm	1030	1030	1030
Machine width (without squeegee)	mm	570	570	570
Machine width (without squeegee + optional splash guard kit)	mm	580	580	580
Battery compartment (l x w x h)	mm	353 / 333 / 250	353 / 333 / 250	353 / 333 / 250
Rated battery voltage	Nr / V / Ah	2 / 12 / 77	2 / 12 / 77	2 / 12 / 77
Battery weight (calculated with 12 V 77Ah battery)	kg	26.5	26.5	26.5
Machine weight (machine + brush + squeegee)	kg	69	76	69
Machine weight in transport (machine + batteries + brush + squeegee)	kg	122	129	122
Machine weight in running order (machine + batteries + water + brush + squeegee)	kg	163	170	163
Sound pressure level (ISO 11201) - L <sub>pA</sub>	dB (A)	52.9	63	52.9
Uncertainty K <sub>pA</sub>	dB (A)	1.5	1.5	1.5
Hand vibration level (ISO 5349)	m/s <sup>2</sup>	0.663	0.612	0.663
Uncertainty of measurement of vibrations		6%	6%	6%



## SYMBOLS USED ON THE MACHINE



Symbol for main switch or key switch (only for B-BT version).  
Used on the control panel, to indicate the key switch for machine operation on (I) or off (0).



ECO mode symbol (only for B-BT version).  
Used on the control panel to indicate the button that activates the ECO mode of the machine.

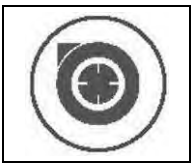

Vacuum motor symbol (only for B-BT version).  
Used on the control panel to indicate the button that commands vacuum motor operation.



"Auto" work mode symbol (Only for B-BT version).  
Used on the control panel to indicate the button that commands the brush motor function on the vacuum motor and the proportional solenoid valve.



Reverse drive selector symbol (only for BT version).  
Used on the control panel to indicate the button for engaging the reverse gear.



Proportional solenoid valve open/close symbol (only for BT version).  
Used on the control panel to indicate the button that commands proportional solenoid valve delivery flow operation.



Symbol denoting proportional solenoid valve open (only for B version).  
Used on the control panel to indicate the button that commands proportional solenoid valve delivery flow operation.



Proportional solenoid valve close symbol (only for B version).  
Used on the control panel to indicate the button that commands proportional solenoid valve delivery flow operation.



Brush uncoupling symbol (only for B-BT version).  
Used on the control panel to indicate the button for uncoupling the brush.



## SYMBOLS USED ON THE MACHINE



Traction motor potentiometer symbol (only for BT version).  
Used on the control panel to indicate the knob that commands the potentiometer that controls the traction motor.



Main switch position "ON- SOLENOID VALVE" symbol (Only for BB version).  
Used on the control panel to indicate the button that commands the activation of the brush motor and the solenoid valve.



Main switch position "OFF" symbol (Only for BB version).  
Used on the control panel to indicate the button that commands the deactivation of the brush motor and of the solenoid valve.

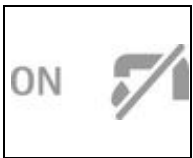

Main switch position "ON- NO SOLENOID VALVE" symbol (Only for BB version).  
Used on the control panel to indicate the button that commands the activation of the brush motor but not of the solenoid valve.



Symbol for vacuum motor switch "ON - VACUUM" (only for BB version).  
Used on the control panel to indicate the button that commands vacuum motor operation.



Symbol for vacuum motor switch "OFF - VACUUM" (only for BB version).  
Used on the control panel to indicate the button that commands vacuum motor switch-off.



Brush uncoupling symbol (only for BB version).  
Used on the instrument panel to indicate the button for automatic brush uncoupling



Work direction control symbol (Only for B-BB version).  
Used on the brush head unit to indicate the knob which allows users to control the work direction of the machine in working mode.

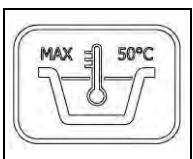

Symbol indicating the maximum temperature of the water used to fill the solution tank



## SYMBOLS USED ON THE MACHINE

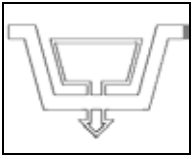

Symbol indicating the position of the solution tank drain cap.



Symbol indicating the position of the solution tank filter.

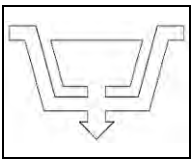

Symbol indicating the position of the recovery tank drainage tube



Detergent flow control symbol.

Used on the machine to indicate the position of the lever used to control the flow of the detergent solution present in the water system.



Parking brake symbol (only for BT version).

Used on the machine to indicate the parking brake control lever

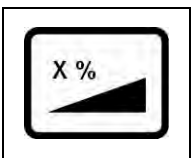

Indicates the maximum gradient





## GENERAL SAFETY REGULATIONS

The regulations below must be carefully followed in order to avoid harm to the operator and damage to the machine.

### WARNING:

- Read the labels on the machine carefully. Do not cover them for any reason and replace them immediately if they become damaged.
- The machine must be exclusively used by authorised, trained personnel.
- Do not use the machine on surfaces with an inclination greater than the one shown on the plate.
- The machine is not suitable for cleaning rough or uneven floors. Do not use the machine on slopes.
- If the power supply cable of the battery charger is damaged, contact an Authorised service centre immediately.
- In case of danger, disconnect the battery connector on the rear of the machine.
- For all maintenance interventions, switch off the machine and disconnect the battery connector and/or the power supply cable.
- Children must be supervised to ensure they do not play with the device.
- During the working of the machine, pay attention to other people and especially to children.
- Only use the brushes supplied with the machine, or those specified in the "CHOOSING AND USING THE BRUSHES" paragraph of the instruction manual. The use of other brushes could compromise safety levels.
- The machine must only be powered with a voltage equal to the one shown on the serial number plate.

### WARNING:

- The machine is not suitable for use by children and persons with reduced physical, mental and sensory capabilities, or people who lack experience and knowledge.
- The machine must not be used or stored outdoors, in damp conditions or directly exposed to rain.
- The storage temperature must be between -25°C and +55°C; do not store outdoors in damp conditions.
- Conditions of use: room temperature between 0°C and 40°C with relative humidity between 30 and 95%.
- The socket for the machine's power cable (electric version) or for the battery charger power cable (battery version) must be correctly earthed.
- Adapt the speed to the adhesion conditions.
- Do not use the machine as a means of transport.
- The machine does not cause harmful vibrations.
- Do not use the machine in an explosive atmosphere.
- Do not vacuum inflammable liquids.
- Do not use the device to collect dangerous powders.
- Do not mix different types of detergent as this may produce harmful gases.
- The machine is not suitable for cleaning carpets.
- Do not place any liquid containers on the machine.
- Avoid working with the brushes when the machine is standing still, so as not to damage the floor.
- In the event of a fire, use a powder extinguisher. Do not use water.
- Do not knock against shelving or scaffolding, where there is a danger of falling objects. The operator must always be equipped with the appropriate safety devices (gloves, shoes, helmet, goggles, etc.).
- The machine is designed to carry out the scrubbing and drying operations simultaneously. Different operations should only be carried out in areas where the passage of unauthorised persons is prohibited. Signal the presence of damp floors with suitable signs.
- If the machine does not work properly, check this is not caused by failure to carry out routine maintenance. Otherwise, ask for intervention of the authorised technical assistance centre.
- If you need to replace any components, request the ORIGINAL spare parts from an Authorised dealer and/or Retailer.
- Restore all electrical connections after any maintenance interventions.
- Before using the machine, check that all the hatches and covers are positioned as shown in this Use and Maintenance Manual.
- Do not remove the guards that can only be removed with the aid of tools, except for maintenance work (see the relevant paragraphs)
- Do not wash the machine with direct water jets or with pressurised water, nor with corrosive substances.
- To prevent scaling in the solution tank filter, do not fill the tank with detergent solution many hours before using the machine.
- Do not use acid or basic solutions that could damage the machine and/or harm people.
- Have the machine checked by an authorised technical assistance centre every year.
- When disposing of consumable materials, observe the laws and regulations in force.
- When your machine has reached the end of its long working life, dispose of the materials it contains (especially oils, batteries and electronic components) in an appropriate manner, taking into account that the machine itself was constructed using 100% recyclable materials.
- The batteries must be removed from the machine before its disposal. The batteries must be disposed of in a safe manner, fully observing the laws and regulations in force.



## MACHINE PREPARATION

### 1. HANDLING OF THE PACKED MACHINE

The machine is contained in specific packaging with a pallet for the handling with fork trucks. The packages cannot be placed on top of each other.

Gross weight of machine with packaging:

iMx version B: 94 kg  
iMx version BT: 101 kg  
iMx version BB: 94 kg

The dimensions of the packaging are as follows:

A= 1170mm  
B= 660mm  
C= 1430mm

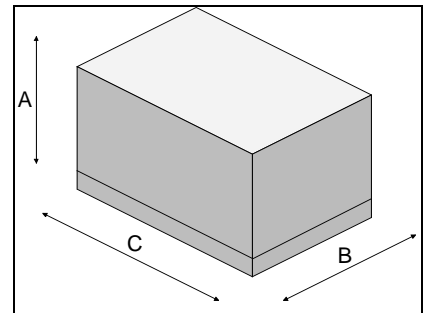

1. Remove the outer package.
2. The machine is fixed to the pallet with wedges which block the wheels
3. Remove the wedges
4. Disconnect the parking brake (only for BT versions), rotate the lever (1) on the right side of the machine anti-clockwise.

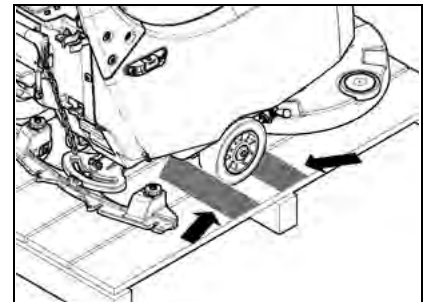

5. Use a chute to get the machine down from the pallet, pushing it backwards. Do not assemble the rear squeegee before unloading the machine, and avoid violently jolting the brush head. To assemble the squeegee, read the "ASSEMBLING THE SQUEEGEE" paragraph.

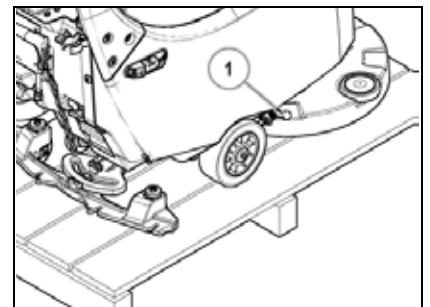

**WARNING:** During transport operations, the instrument panel may be activated but the machine is still off.

6. Keep the pallet for any future transport needs.



**WARNING:** If the product is delivered in cardboard containers, handle the packed product with suitable lifting means that comply with the legal requirements



**WARNING:** During this operation, check there are no people or objects near the machine



## MACHINE PREPARATION

### 2. HOW TO MOVE THE MACHINE

1. Using a chute, mount the machine on the pallet. Carry out this operation with the rear squeegee and the brush detached from the machine.
2. Check the solution tank and recovery tank are empty; if necessary, empty them
3. Check that the main machine switch is in position "0" (for B-BT versions) or "OFF" (for BB versions). If this is not the case, place the switch in this position.
4. Disconnect the electric system connector from the battery connector
5. Secure the machine to the pallet using wooden wedges
6. Apply the parking brake (only for BT version).

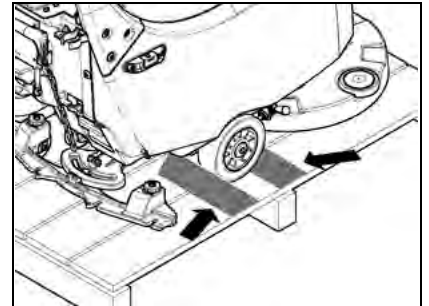

### 3. FRONT MACHINE COMPONENTS

The front components of the machine are identified as follows:

1. Direction control knob.
2. Fast water filler cap.
3. Water filler cap, detergent dispenser.
4. Recovery tank lifting handle

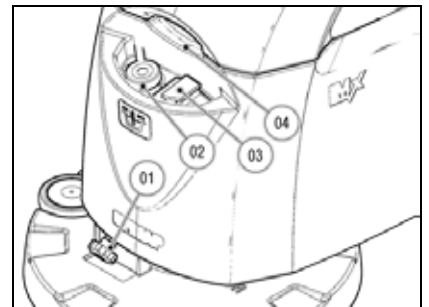

### 4. SIDE COMPONENTS OF THE MACHINE

The components on the left-hand side of the machine are identified as follows:

1. Cap - solution tank filter.
2. Solution tank filler level tube.
3. Vacuum support cover – brush – squeegee body.
4. Detergent solution flow control lever.

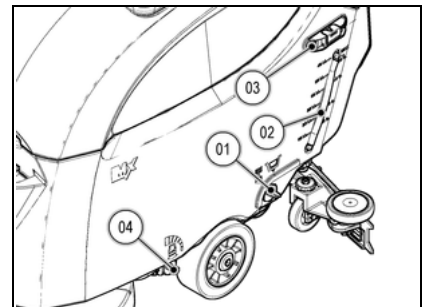

The components on the right-hand side of the machine are identified as follows:

5. Parking brake lever (only for BT version).

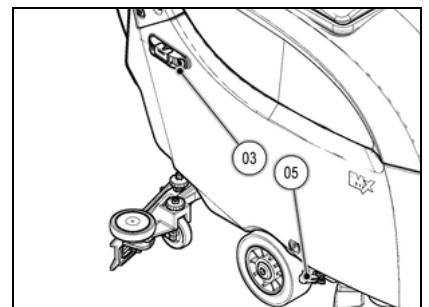

### 5. REAR COMPONENTS OF THE MACHINE

The components at the rear of the machine are identified as follows:

1. Main switch with key (B-BT versions).
2. Squeegee body control lever.
3. Electrical system connector
4. Document compartment cover or battery charger power cable (CB version).

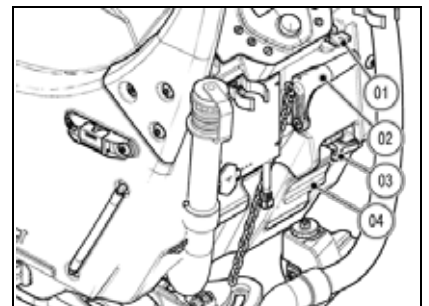



## MACHINE PREPARATION

5. Squeegee vacuum hose
6. Battery charger connector cable cap.
7. Recovery tank drainage tube

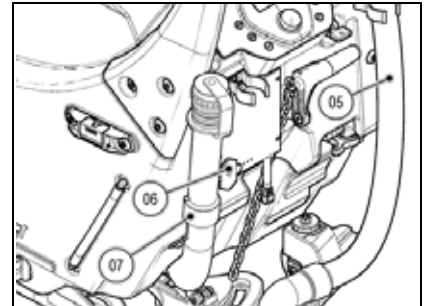

8. Control handlebar, with dead man's lever beneath.
9. Vacuum motor tube.
10. Recovery tank lifting handle.
11. Recovery tank cover

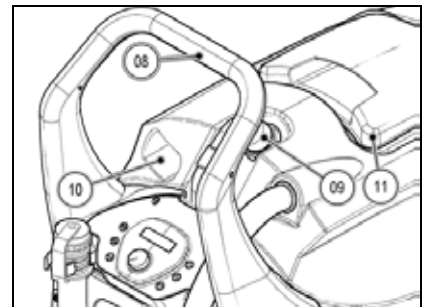

### 6. CONTROL PANEL COMPONENTS (VERSION B)

The control panel components are identified as follows:

1. Level indicator for battery/hour meter.
  2. "ECO" function button
  3. Vacuum motor control button.
  4. "AUTO" function button.
- 
5. Proportional solenoid valve control button, increases the detergent flow.
  6. Proportional solenoid valve control button, decreases the detergent flow.
  7. Brush uncoupling button.

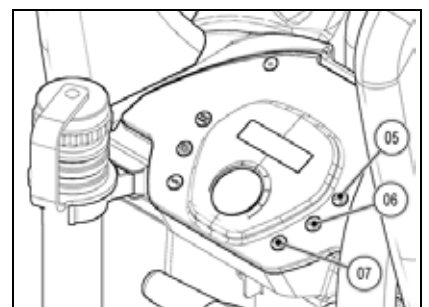
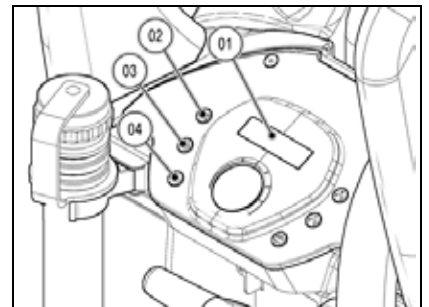

### 7. CONTROL PANEL COMPONENTS (VERSION BT)

The control panel components are identified as follows:

1. Level indicator for battery/hour meter.
2. Speed regulation knob (only for BT version).

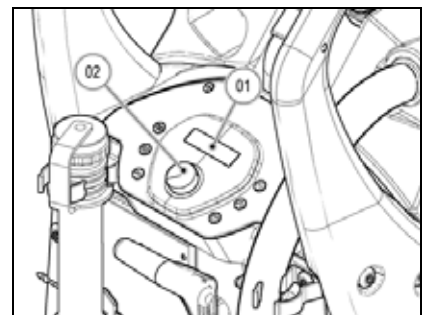



## MACHINE PREPARATION

3. "ECO" function button.
4. Vacuum motor control button.
5. "AUTO" function button.

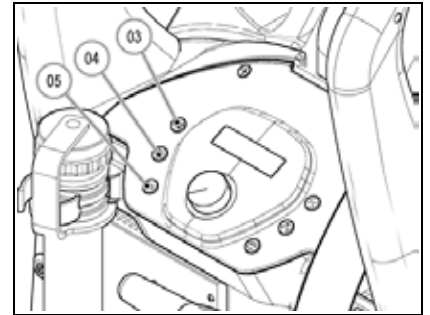

6. Reverse button
7. Proportional solenoid valve control button.
8. Brush coupling/uncoupling button.

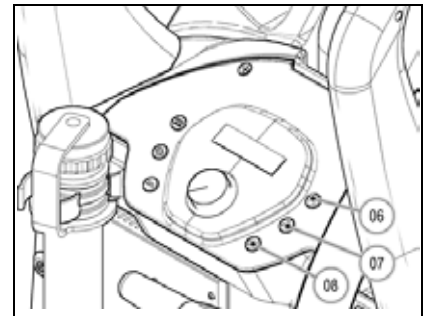

### 8. CONTROL PANEL COMPONENTS (VERSION BB)

The control panel components are identified as follows:

1. Level indicator for battery/hour meter.
2. Main switch with three positions:  
Position "I": Switch in "ON + SOLENOID VALVE ON" position activates the brush motor and the solenoid valve  
Position "0": Switch in "OFF" position interrupts the power supply in the machine's electrical system.  
Position "II": Switch in "ON + SOLENOID VALVE OFF" position activates the brush motor but not the solenoid valve
3. Vacuum motor control button.  
Position-01: Switch in "ON - VACUUM" position activates the vacuum motor  
Position-02: Switch in "OFF - VACUUM" position deactivates the vacuum motor
4. Brush uncoupling switch.

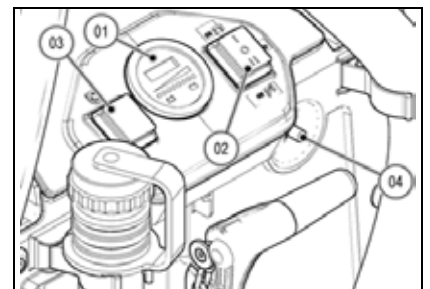
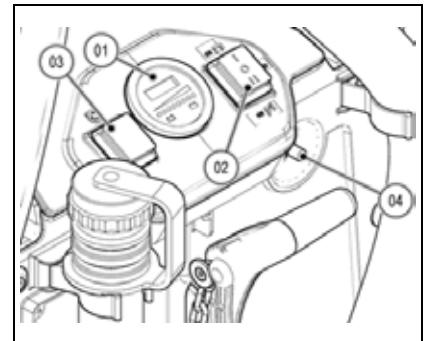

**WARNING:** From this point on in the document the positions of the main switch (02) will be identified with "I or 0 or II".

**WARNING:** from this point on in the document, the positions of the vacuum motor control switch (03) will be identified with "Pos.-01" or "Pos.-02".

### 9. TYPE OF BATTERY

Power to the machine must be supplied by two sealed traction batteries with gas recombination or gel technology. The batteries must meet the requirements laid out in the norms: CEI EN 60254-1:2005-12 (CEI 21-5) + CEI EN 60254-2:2008-06 (CEI 21-7).

For optimum performance, the use of two 12V 77Ah/C5 batteries is recommended (size: 330 mm x 169 mm x H233mm each with a weight of 27 kg), or two 12V 75Ah/C5 batteries (size: 259 mm x 169 mm x H227mm each with a weight of 25 kg).



**WARNING:** If batteries with weights or dimensions differing from those advised above are used, the machine performance could vary considerably.





## MACHINE PREPARATION

### 10. BATTERY MAINTENANCE AND DISPOSAL

For maintenance and recharging, respect the instructions provided by the battery manufacturer. Particular attention must be paid when choosing the battery charger, if not supplied, since there are different kinds according to the type and capacity of the battery. When the battery reaches the end of its working life, it must be disconnected by expert, trained personnel then removed from the battery compartment with the aid of suitable lifting devices. DEAD BATTERIES ARE CLASSIFIED AS DANGEROUS WASTE AND MUST BE DELIVERED TO THE AUTHORISED BODIES FOR CORRECT DISPOSAL.

### 11. HANDLING - INSERTING BATTERIES

The batteries must be housed in the special compartment beneath the recovery tank and should be handled using lifting equipment that is suitable in terms of both weight and coupling system. They must also satisfy the requirements of Standard CEI 21-5. The dimensions of the battery compartment are: 353 mm x 333 mm x H250mm.



**WARNING:** Ensure that you comply with the accident prevention regulations in force in the country where you work or with DIN EN 50272-3 and DIN EN 50110-1, before any handling of the batteries.



**WARNING:** To prevent an accidental short circuit use insulated tools to connect the batteries, and do not place or drop metal objects on the battery. Remove rings, watches and any clothing with metal parts that may come into contact with the battery terminals.

To insert the batteries into the compartment proceed as follows:

1. Check that the recovery tank is empty; if not, empty it using the tube provided for this purpose (01) positioned at the rear of the machine.
2. Check that the main switch (02) is in the "0" position; if not turn the key a quarter turn to the left (for B-BT version only), and remove the key from the instrument panel. Check that the machine's main switch at the back of the machine is in the "0" position; if not, turn to "0" (for BB version only).
3. Make sure the electric system connector (03) is disconnected from the battery connector; if not, disconnect it.
4. Rest the brush head on the floor.
5. Rest the squeegee on the floor, by moving the lever designed for this purpose, positioned on the rear of the machine.
6. Secure the machine by applying the parking brake, move the lever (04) on the right side of the machine (only for BT versions).
7. Remove the recovery tank drainage tube (01) and lay on the ground.
8. Remove the vacuum motor tube (05) from the connector present on the recovery tank.
9. Remove the squeegee vacuum hose (06) from the hole in the recovery tank.

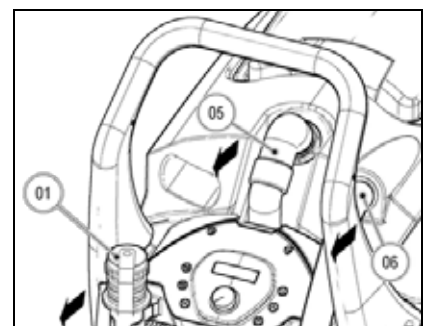
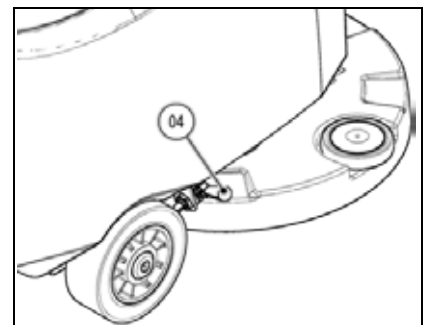
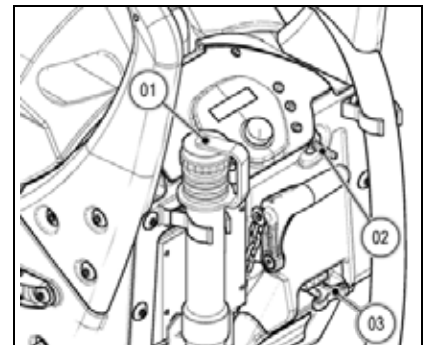



## MACHINE PREPARATION

10. Remove the vacuum cover and attach to the support designed for this purpose, positioned at the rear of the machine.
11. Remove the recovery tank from the machine, taking care with the drainage hose, and rest on a raised surface in order to avoid accidental damage.



**WARNING:** The shape of the recovery tanks means that it can be rested on the ground with the rear part in contact with the floor, in order to avoid accidental damage to the drainage joint.

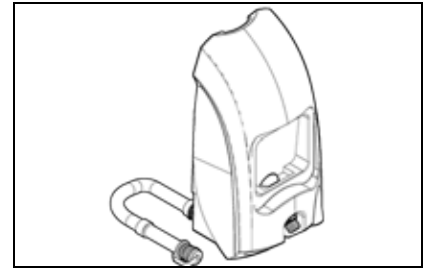

12. Using the correct tool, attach the battery locking blades (07) to the flat base of the batteries.

In the image to the side, the position of the blades for 12V 77Ah batteries is shown (battery size: 259 mm x 168 mm x H208mm each with a weight of 27 kg).

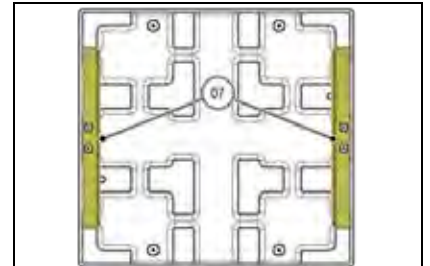

In the image to the side, the position of the blades for 12V 75Ah batteries is shown (battery size: 259 mm x 168 mm x H208mm each with a weight of 25 kg).

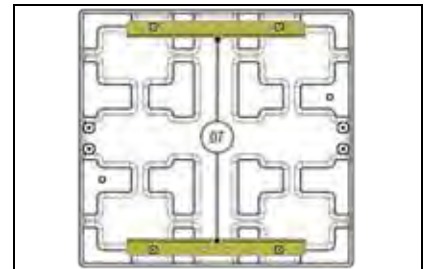

**WARNING:** Before installing the battery, clean the battery compartment with a damp cloth. Check that the connectors on the cables supplied are functioning correctly.

**WARNING:** Check that the characteristics of the battery that you are looking to use are appropriate for the type of work to be performed. Check the battery charge and the condition of the contacts on the battery.



**WARNING:** You are advised to only lift and move the batteries with lifting and transportation means suitable for the specific weight and size

**WARNING:** The lifting hooks must not damage the blocks, connectors or cables.

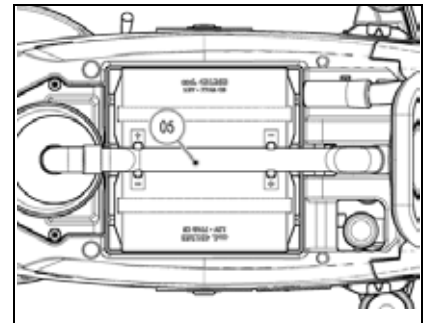

13. Place the batteries in the correct compartments, positioning the "+" and "-" poles opposite each other, taking care not to touch the vacuum motor tube (05).

In the image to the side, the position of the battery blades is shown for 12V 77Ah batteries.



**WARNING:** Before inserting the batteries into the machine, remember to cover the terminals with a little grease to protect them against external corrosion.

In the image to the side, the position of 12V 75Ah batteries is shown. Place the batteries into the correct compartment, positioning the "+" and "-" poles opposite each other as shown in the diagram, taking care not to damage the vacuum motor tube (05).



**WARNING:** Before inserting the batteries into the machine, remember to cover the terminals with a little grease to protect them against external corrosion.

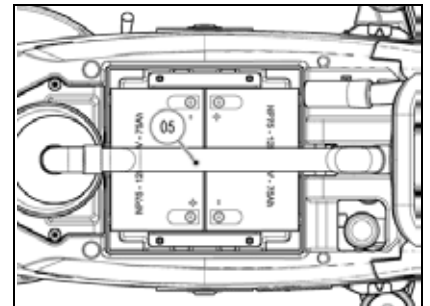



## MACHINE PREPARATION

### 12. CONNECTING THE BATTERIES AND BATTERY CONNECTOR

1. Connect the batteries in series to the "+" and "-" poles using the supplied jumper cable (03).
2. Connect the battery connector cable (02) to the "+" and "-" poles to obtain a voltage of 24V on the terminals.
3. Connect the electrical system connector to the battery connector



**WARNING:** All installation and maintenance operations must be carried out by expert personnel, trained at the specialised assistance centre

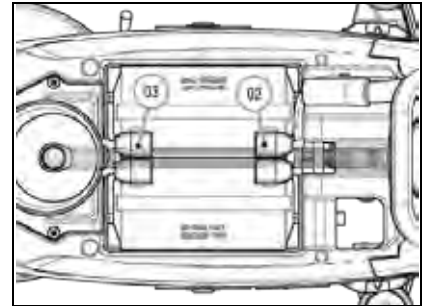

4. Position the machine recovery tank on the machine, ensuring the drainage hose is positioned correctly.
5. Fix the recovery tank drainage tube (01) at the rear of the machine.
6. Insert the vacuum motor tube (05) into the holder at the rear of the recovery tank.
7. Insert the squeegee vacuum hose (06) into the hole at the rear of the recovery tank.

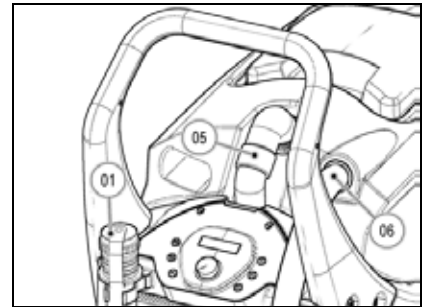

### 13. CONNECTING THE BATTERY CHARGER (VERSIONS WITHOUT BC)

In order not to cause permanent damage to the batteries, it is essential to avoid their complete discharge: arrange the recharge within a few minutes of the switching on of the "discharged batteries" blinking light.



**WARNING:** Never leave the batteries completely discharged, even if the machine is not being used. Check the battery charger is suitable for the batteries installed, in terms of both capacity and type.

To connect the battery charger you must:

1. Move the machine near to the battery charger
2. Check that the recovery tank is empty; if not, empty it using the tube provided for this purpose (01) positioned at the rear of the machine.
3. Check that the main switch (02) is in the "0" position; if not turn the key a quarter turn to the left (for B-BT version only), and remove the key from the instrument panel. Check that the machine's main switch at the back of the machine is in the "0" position; if not, turn to "0" (for BB version only).

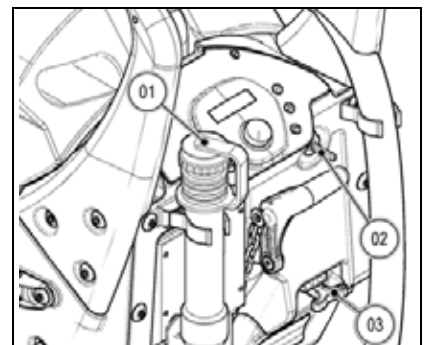

4. Make sure the electric system connector (03) is disconnected from the battery connector; if not, disconnect it.
5. Rest the brush head on the floor.
6. Secure the machine by applying the parking brake, move the lever (04) on the right side of the machine (only for BT versions).

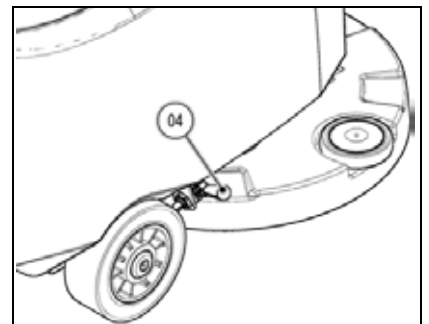

**WARNING:** Park the machine in an enclosed place, on a flat and level surface; near the machine there must be no objects that could either damage it, or be damaged through contact with it.





## MACHINE PREPARATION

7. Remove the recovery tank drainage tube (01) and lay on the ground.
8. Remove the vacuum motor tube (05) from the connector present on the recovery tank.
9. Remove the squeegee vacuum hose (06) from the hole in the recovery tank.

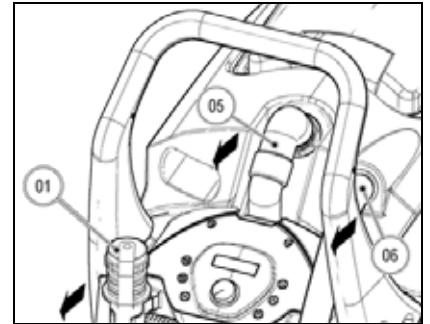

10. Remove the vacuum cover and attach to the support designed for this purpose, positioned at the rear of the machine.
11. Remove the recovery tank from the machine, taking care with the drainage hose, and rest on a raised surface in order to avoid accidental damage.



**WARNING:** The shape of the recovery tanks means that it can be rested on the ground with the rear part in contact with the floor, in order to avoid accidental damage to the drainage joint.



12. Disconnect the electric system connector from the battery connector.
13. Connect the battery charger cable to the battery connector.
14. Connect the recently wired cable to the external battery charger



**WARNING:** Carefully read the use and maintenance instructions of the battery charger that is used for charging.  
**WARNING:** Keep the recovery tank open for the duration of the battery recharging cycle to allow gas fumes to escape  
**WARNING:** The room used to recharge the batteries must be adequately ventilated to prevent the accumulation of gases that leak from batteries.

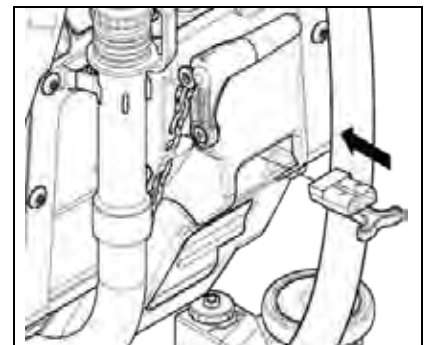

**WARNING:** Danger of gas exhalation and leakage of corrosive liquids.



**WARNING:** Danger of fire: Keep naked flames at a safe distance.

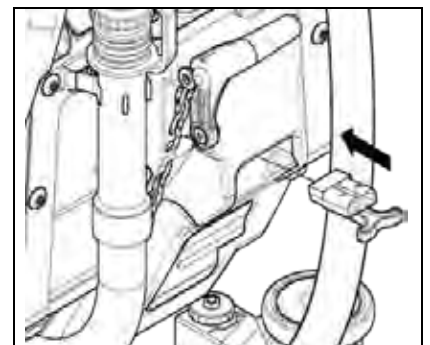

15. When the recharge cycle is complete, disconnect the battery charger connector from the battery connector.
16. Connect the electrical system connector to the battery connector.

17. Position the recovery tank on the machine, ensuring the drainage tube is positioned correctly.
18. Fix the recovery tank drainage tube (01) at the rear of the machine.
19. Insert the vacuum motor tube (05) into the holder at the rear of the recovery tank.
20. Insert the squeegee vacuum hose (06) into the hole at the rear of the recovery tank.

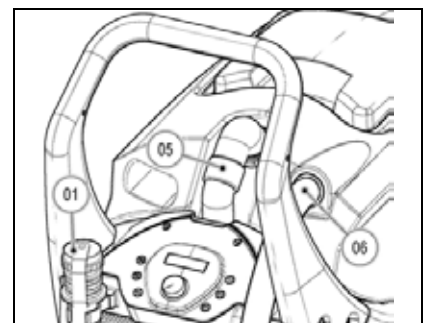



## MACHINE PREPARATION

### 14. CONNECTING THE BATTERY CHARGER (VERSIONS WITH BC)

In order not to cause permanent damage to the batteries, it is essential to avoid their complete discharge: arrange the recharge within a few minutes of the switching on of the "discharged batteries" blinking light.



**WARNING:** Never leave the batteries completely discharged, even if the machine is not being used.

To connect the battery charger you must:

1. Move the machine near to the battery charger
2. Check that the recovery tank is empty; if not, empty it using the tube provided for this purpose (01) positioned at the rear of the machine.
3. Check that the main switch (02) is in the "0" position; if not turn the key a quarter turn to the left (for B-BT version only), and remove the key from the instrument panel. Check that the machine's main switch at the back of the machine is in the "0" position; if not, turn to "0" (for BB version only).
4. Make sure the electric system connector (03) is disconnected from the battery connector; if not, disconnect it.
5. Rest the brush head on the floor.
6. Secure the machine by applying the parking brake, move the lever (04) on the right side of the machine (only for BT versions).



**WARNING:** Park the machine in an enclosed place, on a flat and level surface; near the machine there must be no objects that could either damage it, or be damaged through contact with it.

7. Remove the recovery tank drainage tube (01) and lay on the ground.
8. Remove the vacuum motor tube (05) from the connector present on the recovery tank.
9. Remove the squeegee vacuum hose (06) from the hole in the recovery tank.

10. Remove the vacuum cover and attach to the support designed for this purpose, positioned at the rear of the machine.
11. Remove the recovery tank from the machine, taking care with the drainage hose, and rest on a raised surface in order to avoid accidental damage.



**WARNING:** The shape of the recovery tanks means that it can be rested on the ground with the rear part in contact with the floor, in order to avoid accidental damage to the drainage joint.

12. Remove the cap (07) from the battery charger plug.
13. Connect the battery charger cable to the socket on the charger itself
14. Plug the battery charger cable into the mains socket.



**WARNING:** Keep the recovery tank open for the duration of the battery recharging cycle to allow gas fumes to escape.

**WARNING:** The room used to recharge the batteries must be adequately ventilated to prevent the accumulation of gases that leak from batteries.

The battery charger power cable is delivered inside the bag containing this instruction booklet.

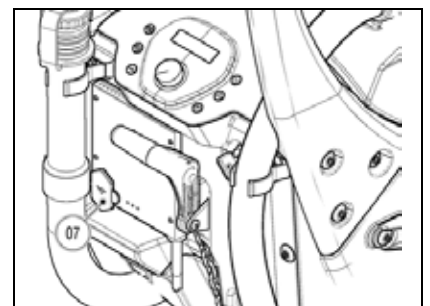
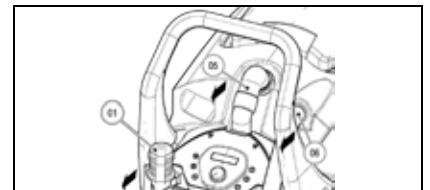
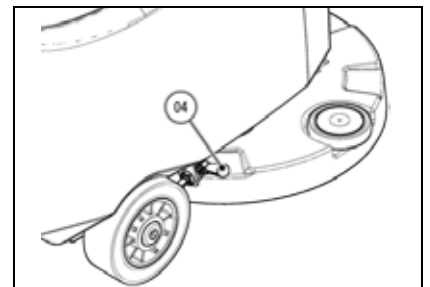
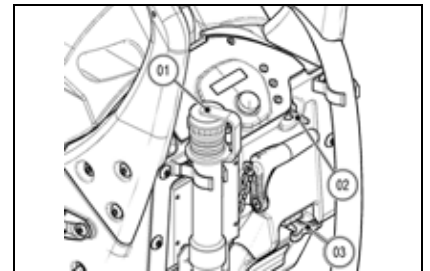



## MACHINE PREPARATION

**WARNING:** Carefully read the use and maintenance manual of the charger that is delivered inside the bag containing this instruction booklet.



**WARNING:** Before inserting the charger power cable into the socket, verify that there is no condensate or other forms of liquids.

**WARNING:** If the machine's electric system is accidentally powered, the command display will show "BATTERY-CHARGER" and none of the steering wheel commands will function (only for B-BT version).

15. When the recharge cycle is complete, disconnect the battery charger power supply cable from wall plug.
16. Disconnect the battery charger cable connector from the plug (08) on the battery charger itself, and insert in the storage drawer (09).
17. Replace the cap (07) on the battery charger plug.

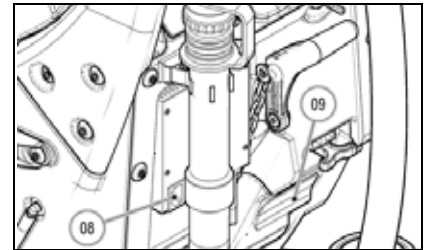

### 15. BATTERY CHARGE LEVEL INDICATOR (B-BT VERSIONS)

On the instrument panel of the machine there is a monitor (1) indicating (amongst other things) the battery charge status. If the lower line contains ten light indicators, the battery charge level is 100%. If the battery charge percentage is at 00% and flashing, this means the batteries are discharged.



**WARNING:** a few seconds after the battery charge level reaches 20%, the brush motor switches off automatically. With the remaining charge it is possible to complete the drying process before starting the recharge.

**WARNING:** a few seconds after the battery charge level reaches 10%, the vacuum motor switches off automatically. With the remaining charge, it is still possible, however, to move the machine to the location designated for its recharging (only for BT versions).

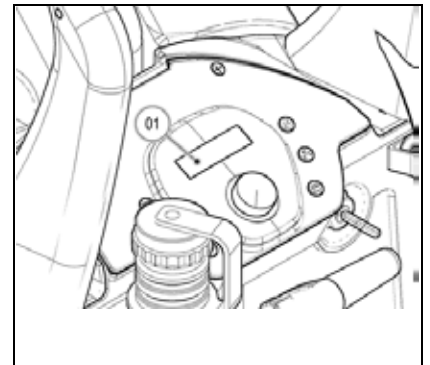

### 16. HOUR METER (B-BT VERSIONS)

On the machine's instrument panel there is a display (1) indicating the total machine usage time. The top line shows the hours and minutes of functioning. The flashing ":" symbol indicates that the hour meter is counting the machine functioning time.

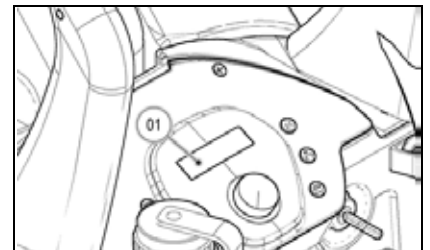

### 17. BATTERY CHARGE LEVEL INDICATOR (BB VERSIONS)

On the upper part of the display, you will see the total operating time. The line visualised shows the operating hours; the number consists of five figures, plus one figure after the point "." to show the tenth of an hour. The battery indicator uses LEDs and has 8 positions (7 yellow - charged batteries, and 1 red - run down batteries).



**WARNING:** A few seconds after the red indicator light comes on, the brush motor switches off automatically. With the remaining charge it is possible to complete the drying process before starting the recharge.

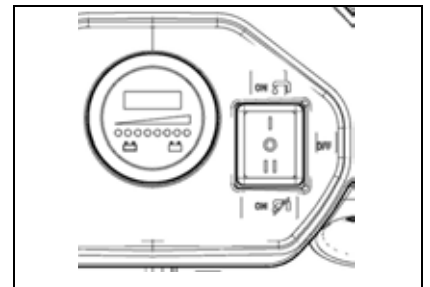



## MACHINE PREPARATION

### 18. FORWARD WORK SPEED (BT VERSIONS)

This machine is equipped with electronic traction control. To move the machine, after turning the key to position "I" simply push the dead man's lever, located under the grip of the handlebar.



**WARNING!** The machine will not start to move (either forward or backward) if the potentiometer adjustment knob (01) is set to minimum.

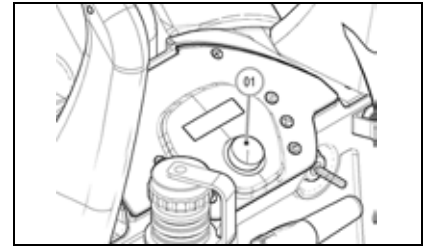

### 19. FORWARD WORK SPEED (B-BB VERSIONS)

The traction of these machines is obtained by means of the brush which, working with the right weight distribution, is able to drag the machine forwards.



**WARNING!** If the machine shows signs of directional imbalance, refer to the section "ADJUSTING THE DIRECTION."

### 20. FILLING THE SOLUTION TANK

Before filling the solution tank, carry out the following steps:

1. The recovery tank must be completely empty each time the solution tank is filled.
2. Check that the brush head and squeegee are resting on the ground; if not, carry out this step.
3. Check that the main switch is in the "0" position; if not turn the key a quarter turn to the left (for B-BT version only), and remove the key from the instrument panel. Check that the machine's main switch at the back of the machine is in the "0" position; if not, turn to "0" (for BB version only).
4. Engage the parking brake by means of the lever on the right side of the machine (only for BT versions).
5. Check that the solution filter cap (02), located on the left side of the machine, is properly closed.

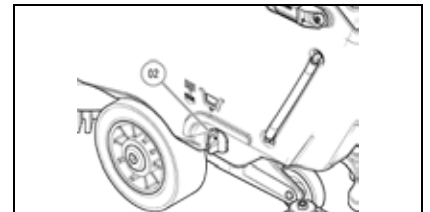
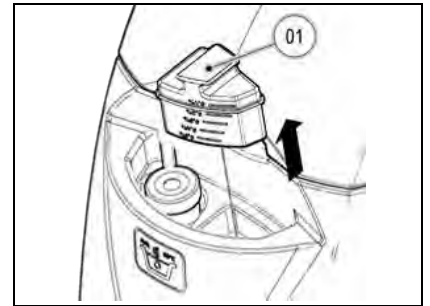

The solution tank can be filled in two different ways:

1. removing the inlet cap (01) and filling with the aid of a rubber tube
2. using the rubber cap (02); this supports the water hose on its own, but be sure to remove the filler cap (01) to allow the proper vent of air.

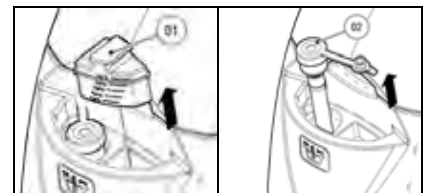

Remove the filler cap (01) and fill with clean water at a temperature not superior to 50°C. The amount inside the tank can be seen by means of the level pipe (03) on the left-hand side at the rear of the machine. Add the liquid detergent to the tank in the concentration and manner indicated on the detergent manufacturer's label. The formation of excess foam could damage the vacuum motor, so use only the minimum amount of detergent that is necessary.



**WARNING!** The filler cap (01) can be used as dispenser for the detergent to be added to the solution tank; the cap features moulded notches identifying the percentage of detergent, ranging from a minimum of 0.1% to a maximum of 0.5%.

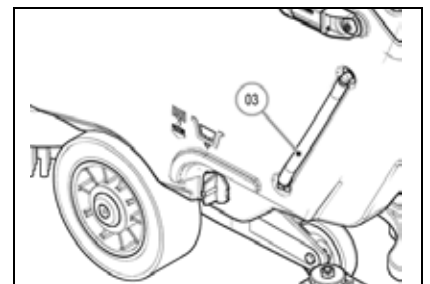



## MACHINE PREPARATION



**WARNING:** Always use detergents whose manufacturer's label indicates their suitability for scrubbing machines. Do not use acid or alkaline products or solvents without this indication. Acid or alkaline maintenance detergents can be used, as long as they have pH values between four and ten, and do not contain oxidising agents, chlorine or bromine, formaldehyde, mineral solvents.



**WARNING:** protective gloves should always be worn before handling detergents or acidic or alkaline solutions to avoid serious injury to hands.



**WARNING:** always use low foam detergent. To avoid the production of foam, before starting to clean, put a minimum quantity of antifoam liquid into the recovery tank. Do not use pure acids.

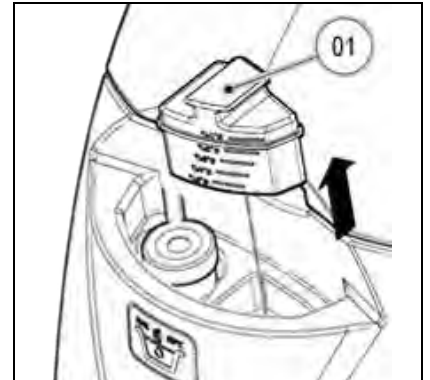

### 21. ASSEMBLING THE SQUEEGEE

The squeegee, that for reasons of packaging comes disassembled from the machine, must be assembled while assembling the machine. Proceed as follows for assembly:

1. Check that the brush head is in contact with the ground: if not, lower it.
2. Turn the machine main switch (01) to the "0" position and remove the key from the instrument panel (B-BT versions). Turn the machine main switch on the rear of the machine to position "0" (for BB version only).
3. Engage the parking brake by means of the lever (02) on the right side of the machine (only for BT versions).
4. Lower the squeegee body by means of the lever (03) on the back of the machine.
5. Loosen the knobs (04) in the squeegee body pre-assembly.
6. First insert the left-hand squeegee pin on the squeegee body into the left-hand slit (05) of the squeegee connection, then tighten the knob (04), making sure the washer and spring adhere in the upper part of the squeegee support.
7. First insert the right-hand squeegee pin on the squeegee body into the right-hand slit (06) of the squeegee connection, then tighten the knob (04), making sure the washer and spring adhere in the upper part of the squeegee support.
8. Insert the vacuum hose (07) in the sleeve (08) on the squeegee body.

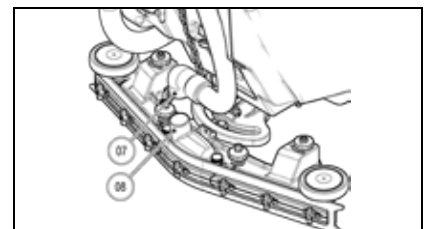
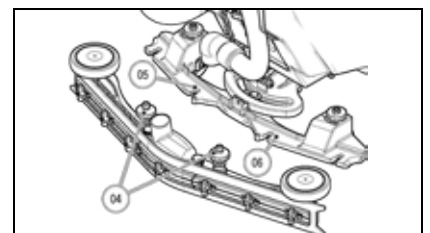
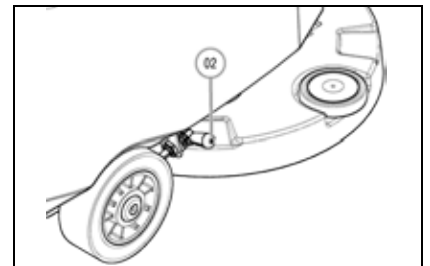
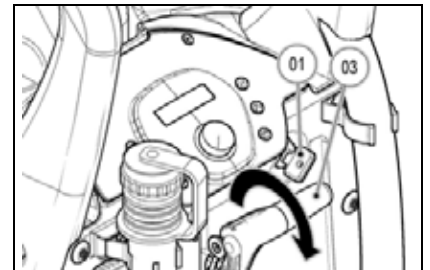

**WARNING:** these operations must be carried out using protective gloves to avoid any possible contact with the edges or tips of metal objects.



## MACHINE PREPARATION

### 22. ASSEMBLING THE BRUSH (B-BT VERSIONS)

To assemble the brushes of the brush head unit, proceed as follows:

1. Raise the brush head from the ground using the control handlebar.
2. Check that the squeegee is raised from the ground; if not, lift using the lever (01).
3. Turn the key operated main switch (02) to position "I".



**WARNING:** During this operation, check there are no people or objects near the brush.

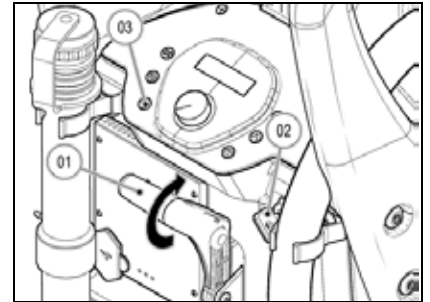

4. Position the brush on the floor, near the machine brush head unit
5. Lower the brush head unit, positioning it on the brush.
6. Press the "AUTO" mode button (03)
7. Pulse the dead man's lever under the control handlebar.



**WARNING:** During this operation, check there are no people or objects near the brush.

**WARNING:** Check the brush is correctly inserted. If this is not the case, the machine could move in an irregular, sudden manner.

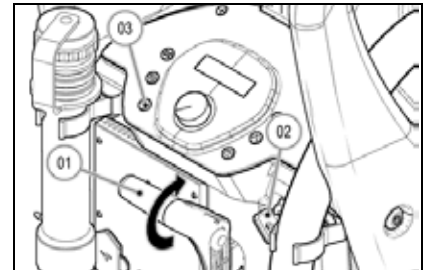

### 23. ASSEMBLING THE BRUSH (BB VERSIONS)

To assemble the brushes of the brush head unit, proceed as follows:

1. Raise the brush head from the ground using the control handlebar.
2. Check that the squeegee is raised from the ground; if not, lift using the lever (01).
3. Set the main machine switch (02) to the "0" position.



**WARNING:** During this operation, check there are no people or objects near the brush.

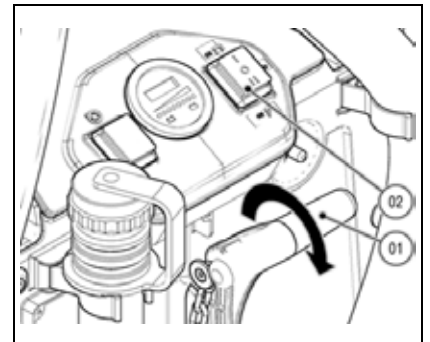

4. Position the brush on the floor, near the machine brush head unit
5. Lower the brush head unit, positioning it on the brush.
6. Press the mode "II" button (02)
7. Pulse the dead man's lever under the control handlebar.



**WARNING:** During this operation, check there are no people or objects near the brush.

**WARNING:** Check the brush is correctly inserted. If this is not the case, the machine could move in an irregular, sudden manner.

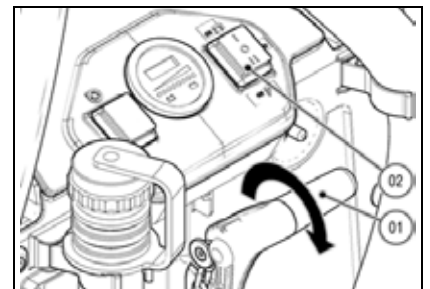

### 24. TRANSPORTATION MODE

If you need to use the machine in transport mode, you must move on the control handlebar (01) (pressing it down) and lift the rear of the machine so that the rear wheel (02) rests on the floor - this allows you to transport the machine safely and easily.



**WARNING:** When carrying out the above, check that the squeegee is raised from the ground; if not, ensure that this is done before proceeding.

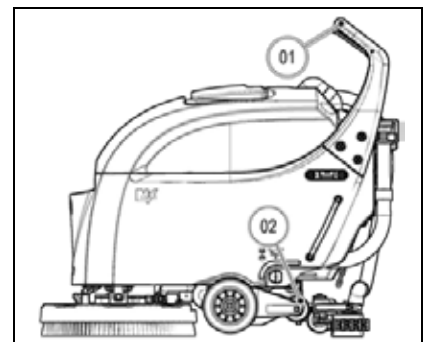



## WORK

### 25. PREPARING TO WORK (B-BT VERSIONS)

Before beginning to work, it is necessary to:

1. Make sure the recovery tank is empty, otherwise empty it completely.
2. Check that the quantity of detergent solution in the solution tank is correct for the type of work to be carried out; if not, refill the solution tank.
3. Check the main switch (01) is in position "0"; if this is not the case, turn the key anticlockwise.
4. Connect the electric system connector (02) to the battery connector.

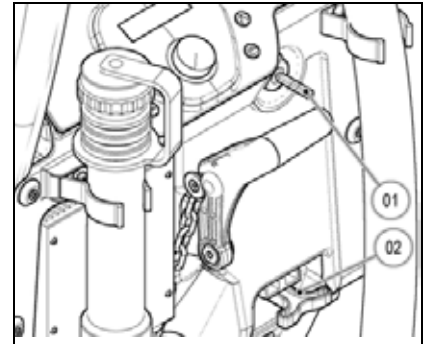

5. Check that the detergent solution tap is fully open; if not, turn the lever (03) on the left-hand side of the machine.
6. Check that the parking brake (04) on the right-hand side of the machine is not engaged; if it is, proceed with removing it (only for BT versions).
7. Turn the main switch key (01) clockwise by a quarter of a turn (to position I). The display on the instrument panel will immediately come on.

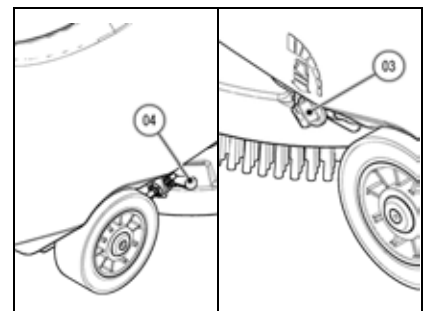

**WARNING:** If the dead man's lever is activated during start-up, the words "LEVER ACTIVATED" will appear on the display and none of the machine controls will function; the dead man's lever must first be released.

With switch-on, three consecutive screens are displayed on the monitor.

The first screen shows the name of the machine model.

The second screen shows the total operation time on the top line, and the programme release is shown on the bottom line.

The third and last screen shows the total operation time on the top line and the battery charge percentage on the bottom line. When the batteries supplied are fully charged, the bottom line contains ten light indicators that represent a battery. As the batteries gradually run down, the indicators go out and, with the batteries completely run down, only the battery outline flashes. The top line indicates the hours and minutes of functioning. The flashing ":" symbol indicates that the hour meter is counting the machine functioning time.



8. Lower the squeegee body by means of the lever (05) on the back of the machine.
9. Press the "AUTO" button (06) on the instrument panel.



**WARNING:** As soon as the "AUTO" button is pressed, the brush motor, vacuum motor and solenoid valve functions can be activated.

**WARNING:** Only pressing the dead man's lever allows the brush motor, vacuum motor and solenoid valve to commence work.

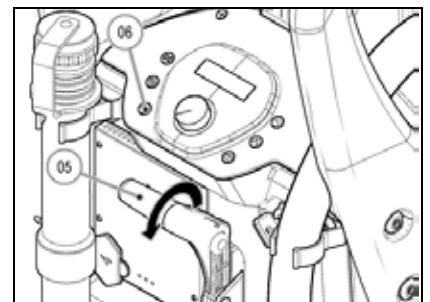

10. Check that the potentiometer adjustment knob (07) is not set to minimum; if this is the case, turn clockwise slightly (only for BT versions).
11. On activation of the dead man's lever, the machine will begin to move.

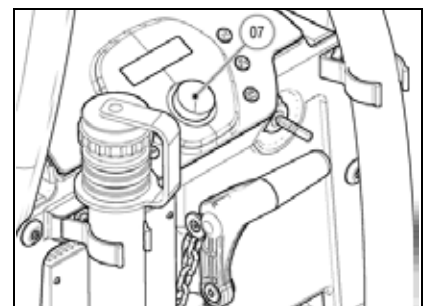



## WORK

During the first few meters, check that the speed is appropriate to the work to be carried out; if not, adjust after reading the section "ADJUSTING WORKING SPEED" (valid only for BT versions).

During the first few meters, check that the detergent solution is appropriate to the work to be carried out; if not, adjust after reading the section "ADJUSTING DETERGENT SOLUTION".

The machine will now begin to work with full efficiency until the battery is flat or until the detergent solution has finished.

If the dead man's lever is released during the scrubbing operation with drying function, the traction motor (BT version), the brush motor and the solenoid valve will stop working; the vacuum motor will continue to function for a period of about fifteen seconds and then be switched off. On the control display, the "A" symbol will remain visible.



**WARNING:** In order to recommence work, simply press the dead man's lever and the traction motor (BT version), brush motor, vacuum motor and solenoid valve will restart.

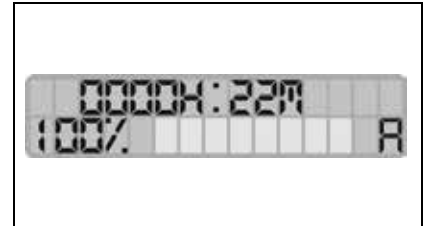

If only the scrubbing function is needed, simply press the button (08) on the control panel and the vacuum motor will stop working immediately after approximately fifteen seconds. On the control display the "A" symbol will disappear and the "O" symbol will appear.

Once the scrubbing cycle is complete, press the button (08) to go back over and dry the scrubbed surface.

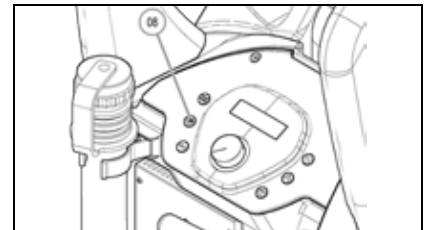

If during the scrubbing operation the dead man's lever is released, the traction motor (BT version) will stop working, the brush motor and the solenoid valve will cease to function. On the control display, the "O" symbol will remain visible.



**WARNING:** In order to recommence work, simply press the dead man's lever and the traction motor (BT version), brush motor and solenoid valve will restart.



If only the scrubbing function is needed without detergent solution, simply press the button (09) on the control panel and hold for a few seconds; the solenoid valve will stop working and the detergent solution supply will cease.

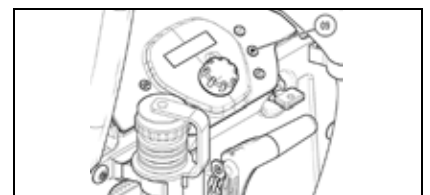

Once the scrubbing cycle without detergent solution is complete, to go back over and dry the scrubbed surface press the button (09) to adjust the release of detergent solution (read paragraph "ADJUSTING DETERGENT SOLUTION").

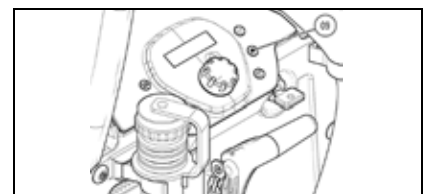

If the dead man's lever is released during the scrubbing operation without detergent solution, the traction motor (BT version) and the brush motor will stop working; the vacuum motor will continue to function for a period of about fifteen seconds and then be switched off. On the control display, the "O" symbol will remain visible.



**WARNING:** In order to recommence work, simply press the dead man's lever and the traction motor (BT version), brush motor and vacuum motor will restart.

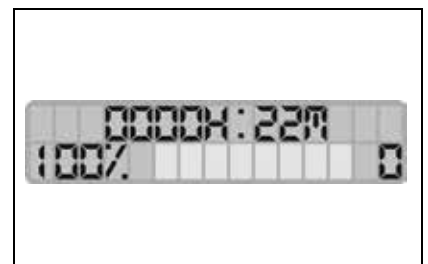





## WORK

If only the drying function is needed, simply press the button (06) on the control panel and the brush motor, the vacuum motor and the solenoid valve will stop working immediately (the vacuum motor will effectively cease to function after approximately fifteen seconds). On pressing the button (08) the vacuum motor will start up again, and the machine can be used in drying mode. On the display, the "0" symbol will disappear, and the text "ASP" will appear. Once the drying cycle is complete, press the button (06) to go back over and dry the scrubbed surface.

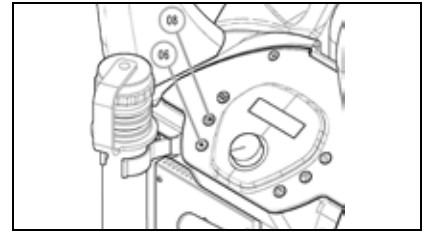

If the dead man's lever is released during the drying operation, the traction motor (BT version) will stop working; the vacuum motor will continue to function for a period of about fifteen seconds and then be switched off. On the control display, the "ASP" symbol will remain visible.



**WARNING:** In order to recommence work, simply press the dead man's lever and the traction motor (BT version) and vacuum motor will restart.



### 26. PREPARING TO WORK (BB VERSIONS)

Before beginning to work, it is necessary to:

1. Make sure the recovery tank is empty, otherwise empty it completely.
  2. Check that the quantity of detergent solution in the solution tank is correct for the type of work to be carried out; if not, refill the solution tank.
  3. Make sure that the main switch (01) is in the "0" position; if not, position it to "0".
  4. Connect the electric system connector (02) to the battery connector.
5. Check that the detergent solution tap is fully open; if not, turn the lever (03) on the rear of the machine.
  6. Place the main switch (01) in position "I". The battery and hour meter display will activate immediately.
  7. Turn the vacuum motor control switch (04) to "Pos.-01". The motor will start up immediately.

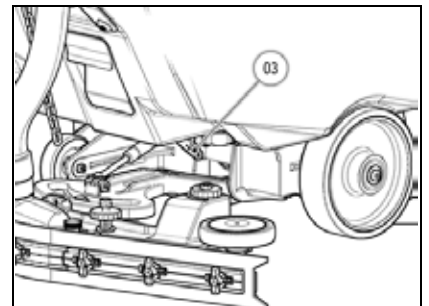
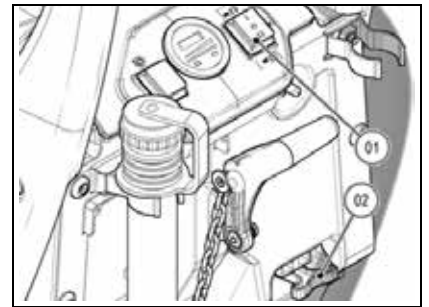

**WARNING:** If the dead man's lever is activated during start up, the machine will begin to function; during the machine start up phase it is advisable to release the dead man's lever.

8. Lower the squeegee body by means of the lever (05) on the back of the machine.
9. On activation of the dead man's lever, the machine will begin to move.

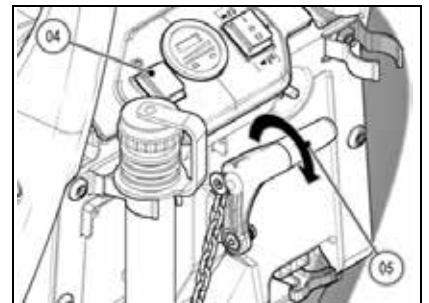

During the first few meters, check that the detergent solution is appropriate to the work to be carried out; if not, adjust after reading the section "ADJUSTING DETERGENT SOLUTION".

The machine will now begin to work with full efficiency until the battery is flat or until the detergent solution has finished.

If the dead man's lever is released during the scrubbing with drying operation, the brush motor and solenoid valve will cease to function; the vacuum motor will continue to work until the button (04) is in position "Pos.-02".



**WARNING:** In order to recommence work, simply press the dead man's lever and the brush motor and solenoid valve will restart. Press the button (04) to activate the vacuum motor if previously switched off.

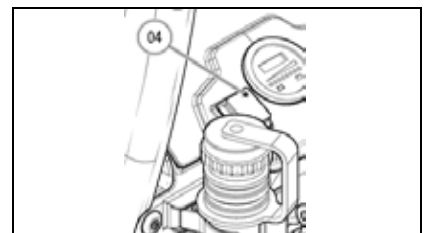



## WORK

If only the scrubbing function is needed, simply turn the button (04) on the control panel to "Pos.-02" and the vacuum motor will immediately cease to function. Once the scrubbing cycle is complete, turn the button (04) to "Pos.-01" to return to the scrub and dry function.

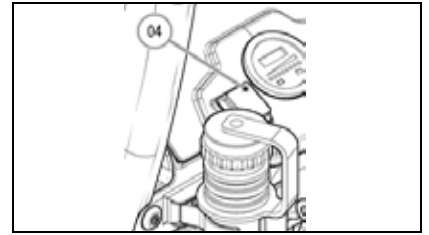

If only the scrubbing function is needed without detergent solution, simply press the button (01) on the control panel in the "II" position; the solenoid valve will stop working and the detergent solution supply will cease.

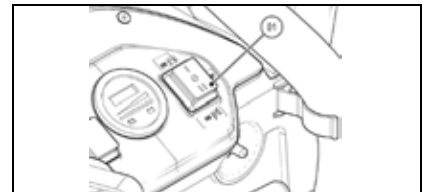

### 27. REGULATING THE DETERGENT (B VERSION)

To regulate the detergent, proceed as follows:

1. Ensure that the tap flow is at maximum capacity by turning the lever (01) on the right-hand rear part of the machine anticlockwise.
2. Check that the quantity of detergent solution in the solution tank is correct for the type of work to be carried out; if not, refill the solution tank.
3. Check that the brush head and squeegee are resting on the ground.
4. Turn the key operated main switch to "I".
5. Press the "AUTO" button on the control panel.
6. Press the dead man's lever under the control handlebar.
7. During the first few metres of work, press the button (02) which controls the proportional solenoid valve in order to increase the flow of detergent supplied to the brush; press the button (03) to decrease the flow.

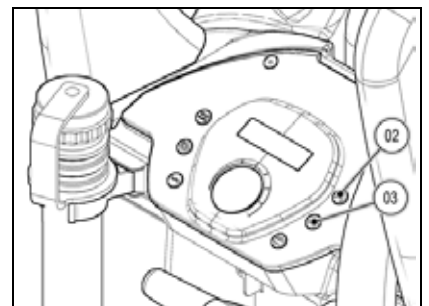
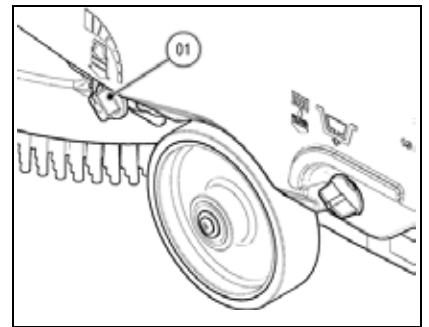

On pressing the detergent solution flow regulation buttons on the control display, a horizontal line will appear, composed of five positions. As the buttons are pressed, small rectangles will appear. There are five possible adjustments for the solenoid valve.

If the display only shows the horizontal line, no detergent solution is being released. This mode is used when the floor is already wet or in general when the chemical action of water and detergent solution is not necessary.



For each press of the button (02), the quantity of solution released will increase by one level. For each press of the button (03), the quantity of solution released will decrease by one level. The quantity of solution released can be set to five different levels.



**WARNING!** Holding the button (03) down brings the solenoid valve flow to zero.

**WARNING!** If the machine is switched off with the key operated main switch, the selected detergent flow will remain in the machine memory.



## WORK

### 28. REGULATING THE DETERGENT (BT VERSION)

To regulate the detergent, proceed as follows:

1. Ensure that the tap flow is at maximum capacity by turning the lever (01) on the right-hand rear part of the machine anticlockwise.
2. Check that the quantity of detergent solution in the solution tank is correct for the type of work to be carried out; if not, refill the solution tank.
3. Check that the brush head and squeegee are resting on the ground.
4. Turn the key operated main switch to "I".
5. Press the "AUTO" button on the control panel.
6. Press the dead man's lever under the control handlebar.
7. During the first few meters of work, press the button (02) which controls the proportional solenoid valve to regulate the flow of detergent solution released onto the brush.

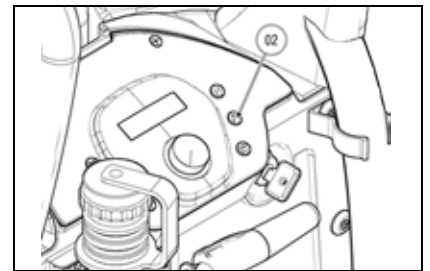
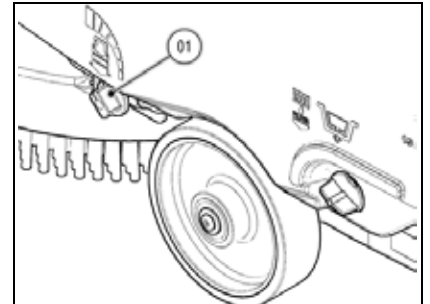

On pressing the button (02) on the control display, a horizontal line will appear, composed of five positions. As the button (02) is pressed, small rectangles will appear. There are five possible adjustments for the solenoid valve.



If the display only shows the horizontal line, no detergent solution is being released. This mode is used when the floor is already wet or in general when the chemical action of water and detergent solution is not necessary.



For each press of the button (02), the quantity of solution released will increase by one level. The quantity of solution released can be set to five different levels. Once the maximum level is reached (status shown in the right-hand display), pressing the button (02) again will return the flow to level 0 (no supply).



**WARNING!** Passing from one step to another is a continuous cycle - it is not possible to go back except by continuing to the end of the scale and starting again from zero.

**WARNING!** Holding the button (02) down brings the solenoid valve flow to zero.

**WARNING!** If the machine is switched off with the key operated main switch, the selected detergent flow will remain in the machine memory.

### 29. REGULATING THE DETERGENT (BB VERSION)

Firstly, fully open the tap outflow, by means of the lever (01) on the right-hand side at the back of the machine. During the first few meters check that the flow of detergent solution is sufficient to wet the floor; the flow of detergent solution is regulated by moving the lever (01). Turning the lever (01) anticlockwise increases the flow of detergent into the water system, while turning the lever (01) clockwise reduces the flow. Bear in mind that the correct amount of solution always depends on the nature of the floor, the degree of dirt and the forward speed.

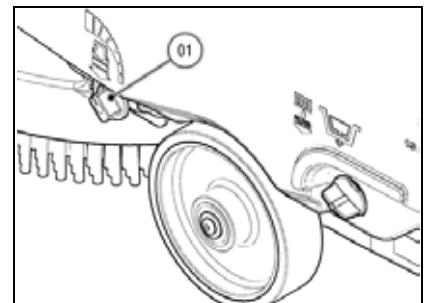



## WORK

### 30. ADJUSTING THE FORWARD WORKING SPEED (BT VERSIONS)

Proceed as follows to adjust the forward speed with the potentiometer:

1. Check that the speed regulation knob (1) is set to minimum.
2. Check that the brush head and squeegee are lifted off the ground.
3. Turn the key operated main switch to "I".
4. Activate the dead man's lever underneath the handlebar; the machine will begin to move.
5. Adjust the desired forward speed by turning the knob gradually clockwise.

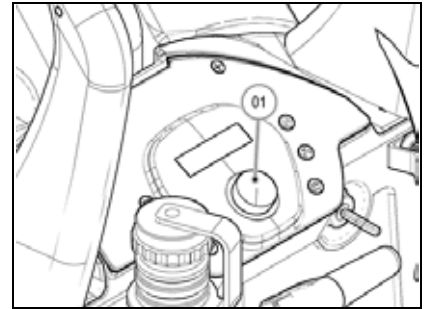

### 31. REVERSE FUNCTION (BT VERSIONS)

To move the machine in reverse, simply press the button (02) on the instrument panel and then immediately afterwards press the dead man's lever, positioned under the handlebar grip.



**WARNING!** The reverse speed is lower than the forward speed to comply with current health and safety standards.

**WARNING!** Remember to raise the squeegee body before activating the reverse function.

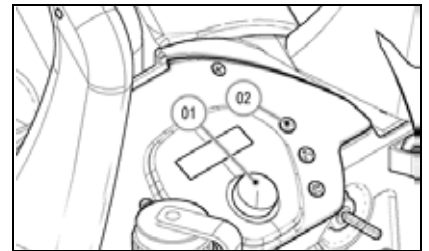

**WARNING!** If the potentiometer is adjusted while reversing, the adjustment of the forward speed will be automatically changed.

**WARNING!** As soon as the button (02) is pressed, the letter R will appear on the display (01).

**WARNING!** As soon as the button (02) is pressed, the acoustic signal advising that reverse function has been activated will sound.

**WARNING!** To take the machine out of reverse function, press the button (02) on the instrument control panel again.

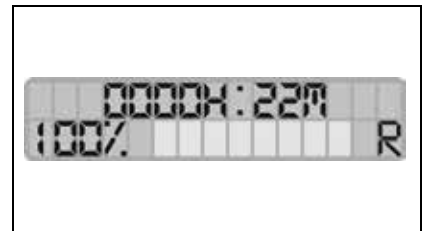

### 32. "ECO" DEVICE (B-BT VERSIONS)

By activating "ECO" mode using the dedicated button (09), the energy used by the machine is reduced, decreasing the power of the brush motor and the vacuum motor. In this mode, the amount of detergent solution released is reduced to the lowest level. The indicator on the display will continue to show the detergent supply level selected in the most recent use. Just press the button (09) on the control panel to deactivate "ECO" mode.

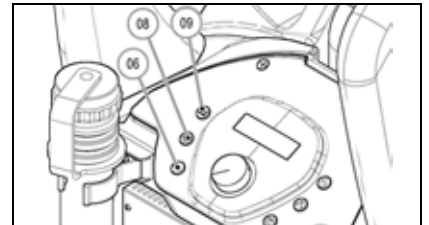

If the dead man's lever is released during the scrubbing operation with drying function in "ECO MODE", the traction motor (BT version), the brush motor and the solenoid valve will stop working; the vacuum motor will continue to function for a period of about fifteen seconds and then be switched off. On the control display, the "A" symbol will remain visible.



**WARNING:** In order to recommence work, simply press the dead man's lever and the traction motor (BT version), brush motor, vacuum motor and solenoid valve will restart.

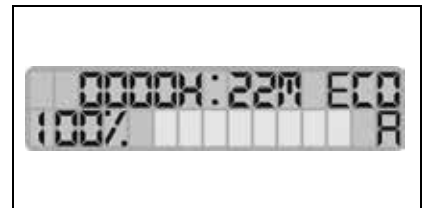

If only the scrubbing function is needed in "ECO MODE", simply press the button (08) on the control panel and the vacuum motor will stop working immediately after approximately fifteen seconds. On the control display the "A" symbol will disappear and the "O" symbol will appear. Once the scrubbing cycle is complete, press the button (08) to go back over and dry the scrubbed surface.

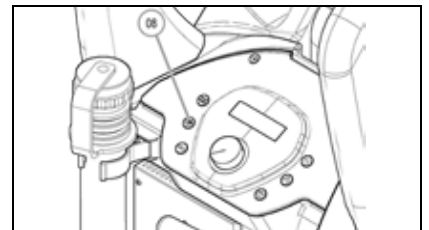



## WORK

If during the scrubbing operation the dead man's lever is released, the traction motor (BT version), the brush motor and the solenoid valve will cease to function. On the control display, the "O" symbol will remain visible.



**WARNING:** In order to recommence work, simply press the dead man's lever and the traction motor (BT version), brush motor and solenoid valve will restart.



If only the scrubbing function is needed without detergent solution in "ECO MODE", simply press the button (09) on the control panel and hold for a few seconds; the solenoid valve will stop working and the detergent solution supply will cease.

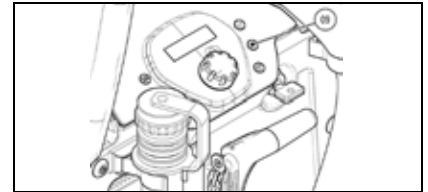

Once the scrubbing cycle without detergent solution is complete, to go back over and dry the scrubbed surface press the button (09) to adjust the release of detergent solution (read paragraph "ADJUSTING DETERGENT SOLUTION").

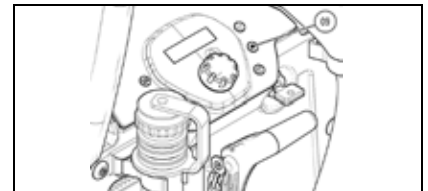

If the dead man's lever is released during the scrubbing operation without detergent solution, the traction motor (BT version) and the brush motor will stop working; the vacuum motor will continue to function for a period of about fifteen seconds and then be switched off. On the control display, the "O" symbol will remain visible.



**WARNING:** In order to recommence work, simply press the dead man's lever and the traction motor (BT version), brush motor and vacuum motor will restart.



If only the drying function is needed in "ECO MODE", simply press the button (06) on the control panel and the brush motor, the vacuum motor and the solenoid valve will stop working immediately (the vacuum motor will effectively cease to function after approximately fifteen seconds). On pressing the button (08) the vacuum motor will start up again, and the machine can be used in drying mode. On the display, the "O" symbol will disappear, and the text "ASP" will appear. Once the drying cycle is complete, press the button (06) to go back over and dry the scrubbed surface.

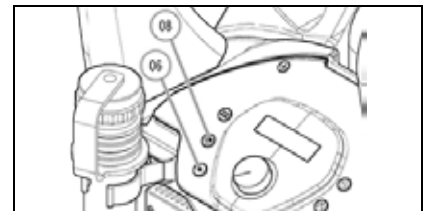

If the dead man's lever is released during the drying operation, the traction motor (BT version) will stop working and the vacuum motor will continue to function for a period of about fifteen seconds and then be switched off. On the control display the "ASP" and "ECO" symbols will remain active, flashing intermittently.



**WARNING:** In order to recommence work, simply press the dead man's lever and the traction motor (BT version) and vacuum motor will restart.

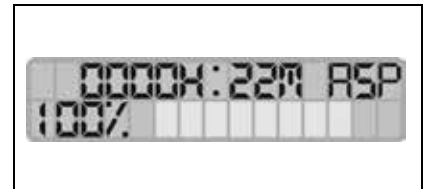

### 33. OVERFLOW DEVICE (B-BT VERSIONS)

The machine is NOT equipped with an overflow device, because the volume of the recovery tank is greater than the capacity of the solution tank. In extraordinary cases, there is a mechanical device (float) under the recovery tank lid that, when the recovery tank is full, shuts off the air to the vacuum motor intake to protect it; the sound of the vacuum motor will then be deeper.

If this is the case, proceed as follows:

1. Switch off "AUTO" mode by pressing the button (01) located in the control panel; the brush motor and the solenoid valve will stop working. After around 15 seconds, the vacuum motor will also stop.

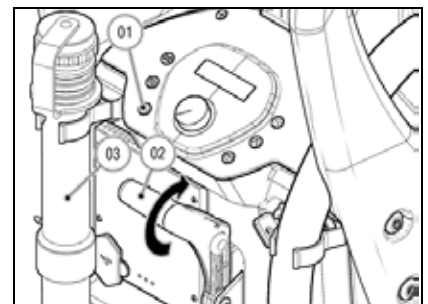



## WORK

2. Raise the squeegee body from the ground by means of the lever (02) on the back of the machine.
3. Take the machine to the designated place for draining off the dirty water and empty the recovery tank, taking care to read the paragraph "EMPTYING THE RECOVERY TANK" carefully first.

It is good practice when restoring the level of the solution tank to empty the recovery tank through the special drainage hose (03).

### 34. OVERFLOW DEVICE (BB VERSIONS)

The machine is fitted with a mechanical device (float) under the recovery tank lid. When the recovery tank is full, this device shuts off the air to the vacuum motor in order to protect it; the sound of the vacuum motor will then be deeper.

If this is the case, proceed as follows:

1. Press the button (01), turning it to position "0"; the brush motor and the solenoid valve will cease to function.
2. Press the button (02), turning it to position "Pos.-02". The vacuum motor will stop working.

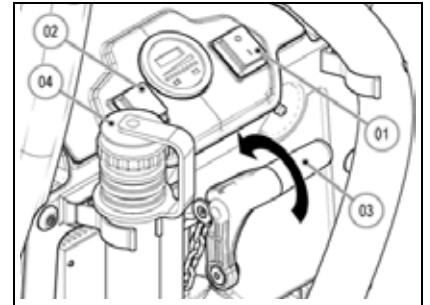

3. Raise the squeegee body from the ground by means of the lever (03) on the back of the machine.
4. Take the machine to the designated place for draining off the dirty water and empty the recovery tank, taking care to read the paragraph "EMPTYING THE RECOVERY TANK" carefully first.

It is good practice when restoring the level of the solution tank to empty the recovery tank through the special drainage hose (04).

### 35. EMPTYING THE RECOVERY TANK (B-BT VERSIONS)

To regulate the detergent, proceed as follows:

1. First, take the machine to the designated place for draining off the dirty water.
2. Check that the brush head and the squeegee are raised off the ground; if not, ensure that this is done before proceeding.
3. Turn the key operated main switch (02) to the "0" position and remove the key from the instrument panel.
4. Engage the parking brake by means of the lever (03) on the right side of the machine (only for BT versions).
5. Disconnect the tube (01) from its seat, unscrew the drainage cap and empty the recovery tank.
6. After emptying the tank, close the cap and insert the tube (01) into the appropriate seat.

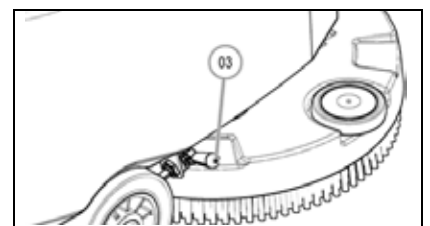
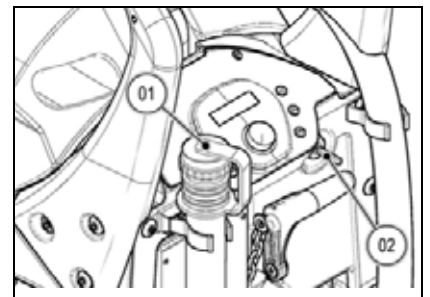

**WARNING:** this operation must be carried out wearing gloves to protect against contact with dangerous solutions.

### 36. EMPTYING THE RECOVERY TANK (BB VERSIONS)

To regulate the detergent, proceed as follows:

1. First, take the machine to the designated place for draining off the dirty water.
2. Check that the brush head and the squeegee are raised off the ground; if not, ensure that this is done before proceeding.
3. Press the button (01), turning it to position "0"; the vacuum motor will stop working.
4. Disconnect the tube (02) from its seat, unscrew the drainage cap and empty the recovery tank.
5. After emptying the tank, close the cap and insert the tube (02) into the appropriate seat.

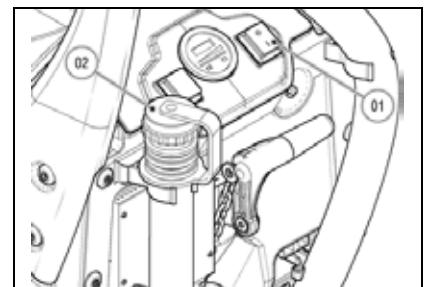



## AT THE END OF WORK

### 37. AT THE END OF WORK (B-BT VERSIONS)

At the end of work, and before carrying out any type of maintenance, perform the following operations:

1. Switch off "AUTO" mode by pressing the button (01) on the instrument control panel.

This will switch off the brush motor and the solenoid valve, while the vacuum motor will remain active for approximately 15 seconds before switching off automatically.

2. Raise the squeegee body from the ground by means of the lever (02) on the back of the machine.
3. Take the machine to the place provided for draining off the dirty water
4. Engage the parking brake by means of the lever (03) on the right side of the machine (only for BT versions).

5. Switch off the power supply to the machine's electrical system using the main switch (04) located on the rear of the machine, turning the key to position "0".
6. Disconnect the electrical connector (05) from the battery connector.



**WARNING:** Before performing any maintenance, remove the keys from the panel and disconnect the battery connector of the machine.

7. Disconnect the recovery tank drainage tube (06) from its housing, unscrew the drainage cap and empty the recovery tank. On completion of the operation, tighten the cap and position the tube (06) in its seat.



**WARNING:** This operation must be carried out wearing gloves to protect against contact with dangerous solutions.



**WARNING:** To avoid damaging the machine or creating foul odours, it is advisable to empty the tanks every time the machine is switched off.

8. Remove the vacuum hose (07) from the sleeve (08) on the squeegee body.
9. Loosen the knobs (09) in the squeegee body pre-assembly.
10. Remove the squeegee body from the slits in the squeegee connector.
11. First with a jet of water and then with a damp cloth, thoroughly clean the vacuum chamber of the squeegee body, the rear rubber blade and the front rubber blade.

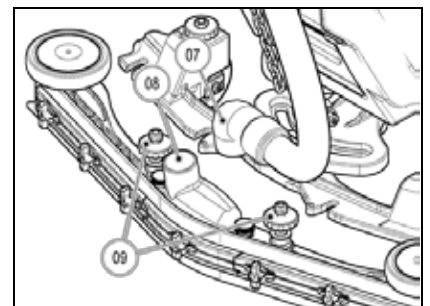
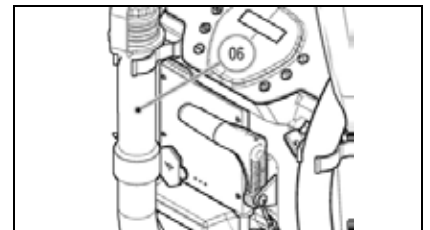
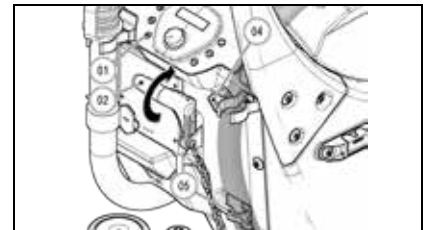
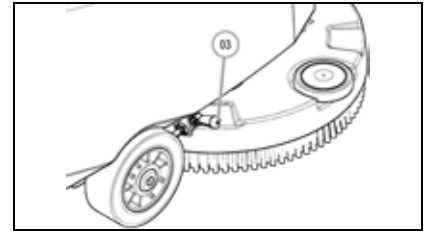
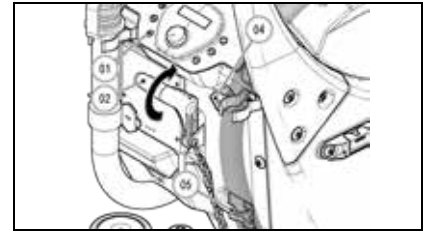



## AT THE END OF WORK

12. Attach the squeegee body to the squeegee connector.
13. Insert the vacuum hose (07) into the sleeve (08) on the squeegee body.

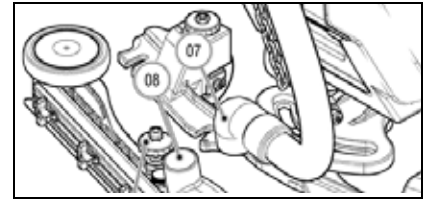

14. If necessary to empty the solution tank, unscrew the tap-filter (10) on the left-hand side of the machine, and when finished, re tighten.

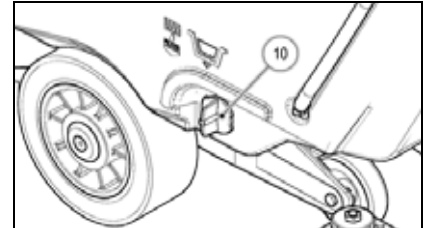

15. Connect the electrical system connector (05) to the battery connector
16. Insert the key into the main switch block (04) and turn it a quarter turn clockwise (to position I)

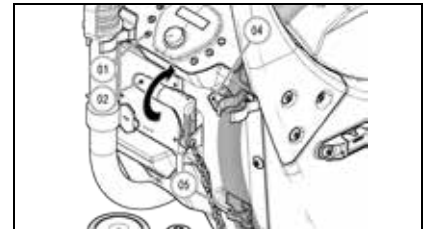

17. Remove the parking brake by means of the lever (03) on the right side of the machine (only for BT versions).

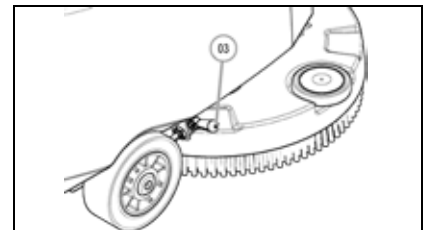

18. Take the machine to the designated machine storage place.
19. Apply the parking brake by means of the lever (03) on the right side of the machine (only for BT versions).
20. Switch off the power supply to the machine's electrical system using the main switch (04) located on the rear of the machine, turning the key to position "0".
21. Disconnect the electrical connector (05) from the battery connector.

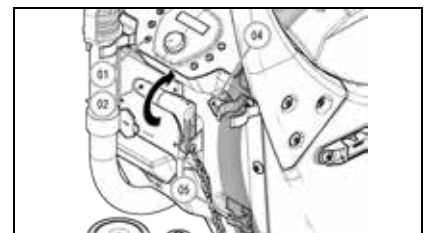

22. Put the machine in rest mode. Using the control handlebar (01) (pushing downwards), lift the rear part of the machine so that the rear wheel (02) rests on the floor.

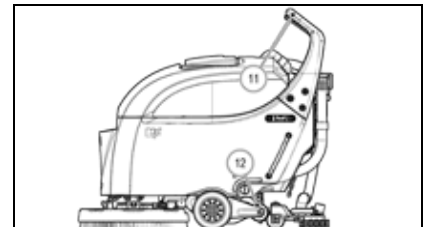

**WARNING:** Park the machine in an enclosed place, on a flat and level surface; near the machine there must be no objects that could either damage it, or be damaged through contact with it.



**WARNING:** Do not leave the machine unattended without first removing the start-up switch key and applying the parking brake (only for BT versions). In addition, do not park the machine in open places or on sloping floors.





## AT THE END OF WORK

### 38. AT THE END OF WORK (BB VERSIONS)

At the end of work, and before carrying out any type of maintenance, perform the following operations:

1. Switch off the vacuum motor using the switch (01) positioned on the rear of the machine.
2. Switch off the power supply to the machine's electrical system using the main switch (02) located on the rear of the machine, turning the key to position "0".
3. Raise the squeegee body from the ground by means of the lever (03) on the back of the machine.
4. Take the machine to the place provided for draining off the dirty water.

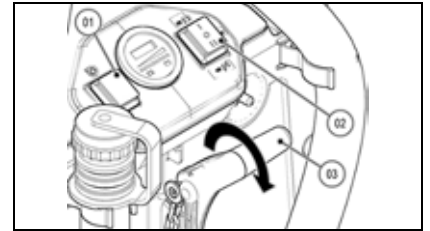
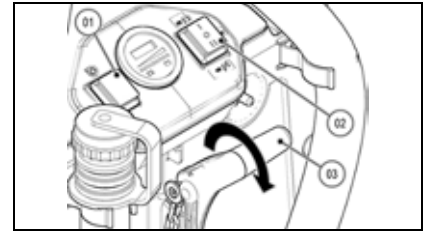

5. Disconnect the electrical connector (04) from the battery connector.



**WARNING:** Before performing any maintenance, remove the keys from the panel and disconnect the battery connector of the machine.

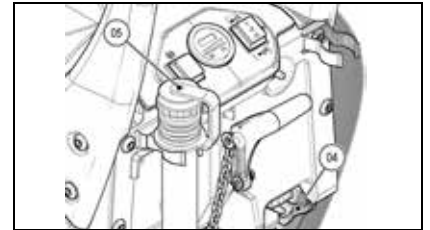

6. Disconnect the recovery tank drainage tube (5) from its housing, unscrew the drainage cap and empty the recovery tank. On completion of the operation, tighten the cap and position the tube (05) in its seat.

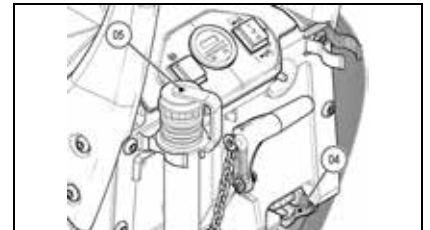

**WARNING:** This operation must be carried out wearing gloves to protect against contact with dangerous solutions.



**WARNING:** To avoid damaging the machine or creating foul odours, it is advisable to empty the tanks every time the machine is switched off.

7. Remove the vacuum hose (07) from the sleeve (08) on the squeegee body.
8. Loosen the knobs (09) in the squeegee body pre-assembly.
9. Remove the squeegee body from the slits in the squeegee connector.
10. First with a jet of water and then with a damp cloth, thoroughly clean the vacuum chamber of the squeegee body, the rear rubber blade and the front rubber blade.

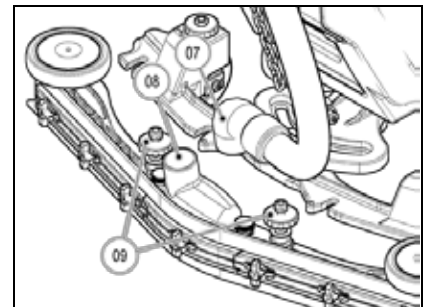



## AT THE END OF WORK

11. Attach the squeegee body to the squeegee connector.
12. Insert the vacuum hose (07) into the sleeve (08) on the squeegee body.

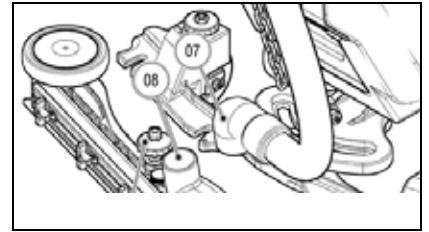

13. If necessary to empty the solution tank, unscrew the tap-filter (10) on the left-hand side of the machine, and when finished, re tighten.

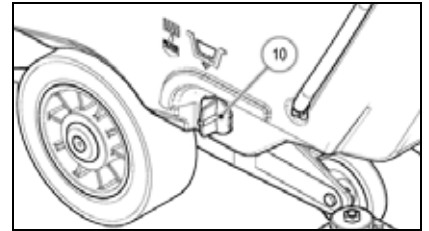

14. Connect the electrical system connector (04) to the battery connector.

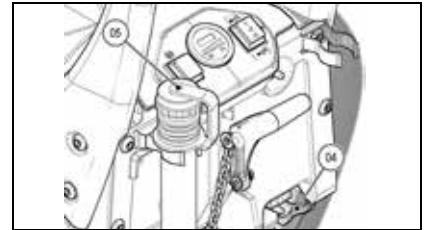

15. Take the machine to the designated machine storage place.
16. Disconnect the electrical connector (04) from the battery connector.

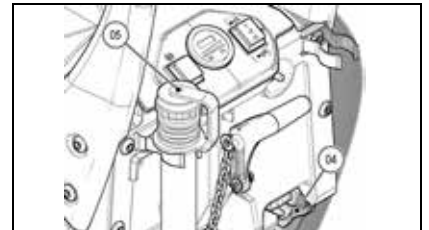

17. Put the machine in rest mode. Using the control handlebar (11) (pushing downwards), lift the rear part of the machine so that the rear wheel (12) rests on the floor.



**WARNING:** Park the machine in an enclosed place, on a flat and level surface; near the machine there must be no objects that could either damage it, or be damaged through contact with it.

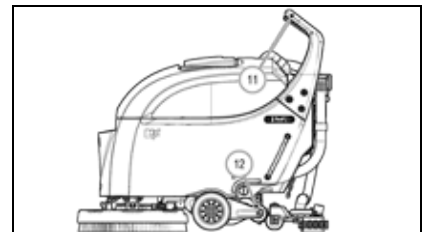



## DAILY MAINTENANCE

### PERFORM ALL MAINTENANCE OPERATIONS IN SEQUENCE

#### 39. CLEANING THE SOLUTION TANK FILTER - CAP

In order to ensure a proper flow of detergent solution into the water circuit, proper cleaning of the solution tank filter is necessary. In order to do this, proceed as follows:

1. Switch off the power supply to the machine's electrical system using the main switch (01) located on the rear of the machine, turning the key to position "0" (valid for versions B-BT).
1. Switch off the power supply to the machine's electrical system using the main switch (01) located on the rear of the machine, turning the key to position "0" (valid for versions BB).
2. Disconnect the electrical connector (02) from the battery connector.
3. Engage the parking brake by means of the lever (03) on the right side of the machine (only for BT versions).
4. Loosen the solution tank filter cap (04).
5. Rinse the cap-filter carefully under running water.
6. Remove any impurities present in the moulded threaded bushing in the solution tank.
7. Reassemble all the elements.



**WARNING:** This operation must be carried out using gloves to protect against contact with dangerous solutions.

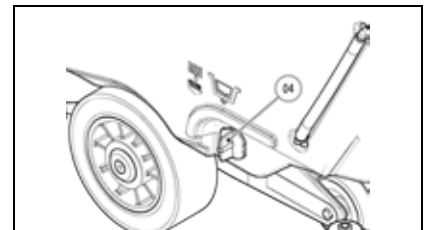
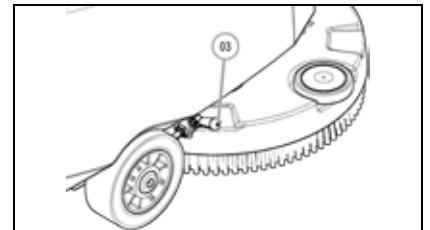
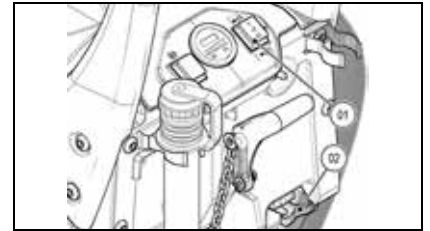
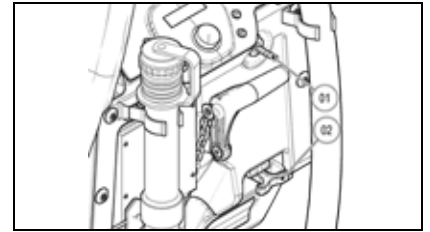

#### 40. CLEANING THE RECOVERY TANK FILTER

To ensure the correct function of the machine's vacuum motor, proper cleaning of the recovery tank filter is necessary. In order to do this, proceed as follows::

1. Switch off the power supply to the machine's electrical system using the main switch (01) located on the rear of the machine, turning the key to position "0" (valid for versions B-BT).
1. Switch off the power supply to the machine's electrical system using the main switch (01) located on the rear of the machine, turning the key to position "0" (valid for versions BB).

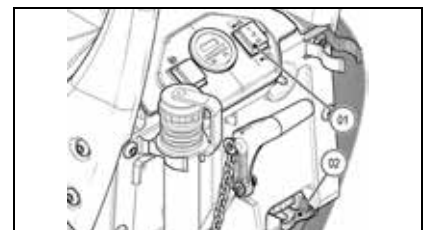
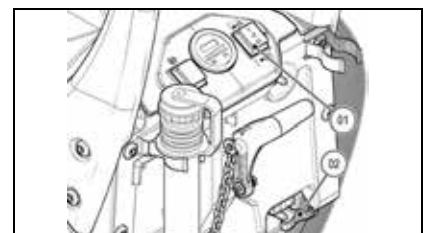



## DAILY MAINTENANCE

2. Disconnect the electrical connector (02) from the battery connector.
3. Engage the parking brake by means of the lever (03) on the right side of the machine (only for BT versions).

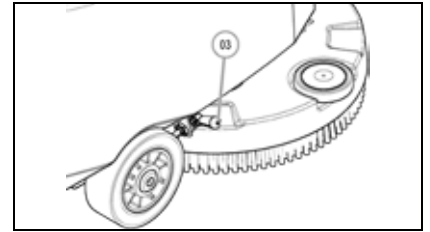

4. Remove the vacuum cover (04) and position on the support (05) designed for this purpose, positioned at the rear of the machine.



**WARNING:** To use the support (05), simply turn the tongue outwards, and once the support function is complete, the tongue can be turned back inwards.

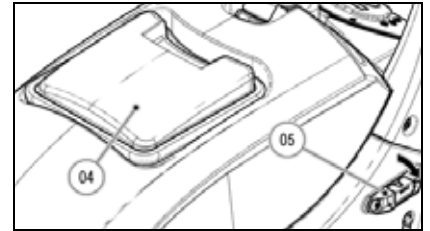

5. Turn the cup (06) anticlockwise and remove from the machine.
6. Remove the recovery tank filter (07).
7. Rinse the cup and filter carefully under running water.
8. Reassemble all the elements.



**WARNING:** This operation must be carried out using gloves to protect against contact with dangerous solutions.

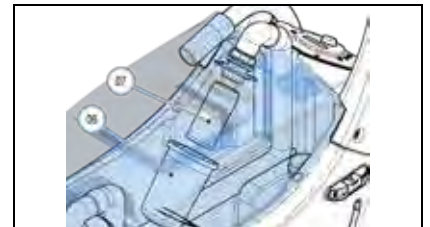

### 41. CLEANING THE BRUSH (B-BT VERSIONS)

To ensure effective floor cleaning, proper cleaning of the brush is necessary. In order to do this, proceed as follows:

1. Make sure the recovery tank is empty, otherwise empty it completely.
2. Check that the squeegee body is raised above the ground; if not, lift using the lever (01) on the rear of the machine.
3. Engage the parking brake by means of the lever (02) on the right side of the machine (only for BT versions).
4. Put the machine in rest mode. Using the control handlebar (pushing downwards), lift the front part of the machine so that the rear wheel rests on the floor.
5. Press the brush release button (03) on the instrument control panel. As soon as the button is pressed, you will see the question "RELEASE?" on the screen. Press the brush release button (03) on the steering wheel again, to confirm.

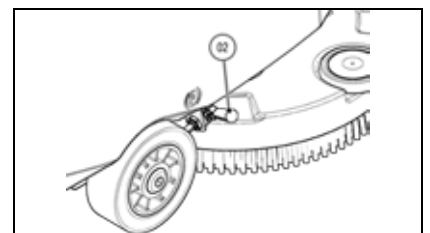
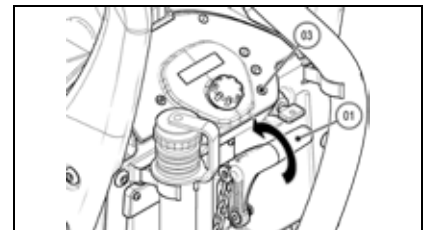

**WARNING:** If the brush does not release, repeat the operation again until the brush is released from the brush head.

**WARNING:** During this operation, check there are no people or objects near the brush.



6. Rinse the brush carefully under running water.
7. Read the paragraph "ASSEMBLING THE BRUSH" before reassembling all components.



**WARNING:** This operation must be carried out using gloves to protect against contact with dangerous solutions.



## DAILY MAINTENANCE

### 42. CLEANING THE BRUSH (BB VERSIONS)

To ensure effective floor cleaning, proper cleaning of the brush is necessary. In order to do this, proceed as follows:

1. Make sure the recovery tank is empty, otherwise empty it completely.
2. Check that the squeegee body is raised above the ground; if not, lift using the lever (01) on the rear of the machine.
3. Make sure that the main switch (02) is in the "II" position; if not, position it to "II".
4. Put the machine in rest mode. Using the control handlebar (pushing downwards), lift the front part of the machine so that the rear wheel rests on the floor.
5. Press the dead man's lever under the control handlebar and simultaneously activate the brush release lever (03) positioned at the rear of the machine. As soon as lever (03) is activated, release dead man's lever under the control handlebar.

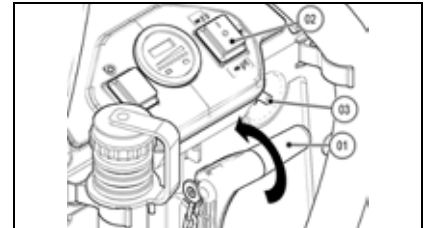

**WARNING:** If the brush does not release, repeat the operation again until the brush is released from the brush head.

**WARNING:** During this operation, check there are no people or objects near the brush.

6. Rinse the brush carefully under running water.
7. Read the paragraph "ASSEMBLING THE BRUSH" before reassembling all components.



**WARNING:** This operation must be carried out using gloves to protect against contact with dangerous solutions.

### 43. CLEANING THE SQUEEGEE BODY

The careful cleaning of the whole vacuum unit ensures better drying and cleaning of the floor as well as greater duration of the vacuum motor.

Proceed as follows for cleaning the squeegee body:

1. Switch off the power supply to the machine's electrical system using the main switch (01) located on the rear of the machine, turning the key to position "0" (valid for versions BB).
1. Switch off the power supply to the machine's electrical system using the main switch (01) located on the rear of the machine, turning the key to position "0" (valid for versions B-BT).
2. Disconnect the electrical connector (02) from the battery connector.
3. Engage the parking brake by means of the lever (03) on the right side of the machine (only for BT versions).
4. Lower the squeegee body by means of the lever (04) on the back of the machine.

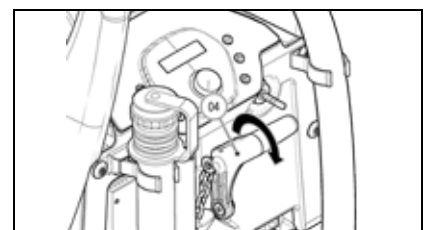
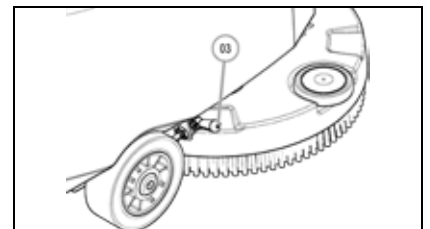
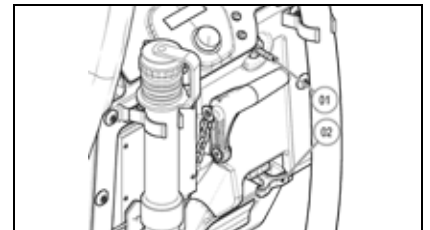



## DAILY MAINTENANCE

5. Remove the vacuum hose (05) from the vacuum nozzle (06) on the squeegee body.
6. Loosen the knobs (07) in the squeegee body pre-assembly.
7. Remove the squeegee body from the slits in the squeegee connector.
8. First with a jet of water and then with a damp cloth, thoroughly clean the vacuum chamber of the squeegee body.

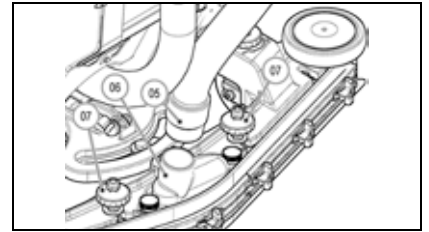

9. First with a jet of water and then with a damp cloth, thoroughly clean the front rubber blade (08) of the squeegee body.
10. Check the wear of the front rubber blade(08) on the squeegee body; if the edge of the rubber in contact with the floor is worn proceed with replacement, reading the paragraph "REPLACEMENT OF SQUEEGEE BODY FRONT RUBBER BLADE" first.



**WARNING:** This operation must be carried out using gloves to protect against contact with dangerous solutions.

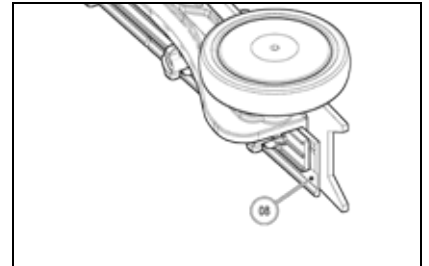

11. First with a jet of water and then with a damp cloth, thoroughly clean the rear rubber blade (09) of the squeegee body.
12. Check the wear of the rear rubber blade (09) on the squeegee body; if the edge of the rubber in contact with the floor is worn, the rubber can be turned onto another of its 4 edges.
13. To remove the rear rubber blade (09), turn the wing nuts (10) to horizontal position, remove the rubber-pressing blades (11) and remove the rear rubber blade (09).

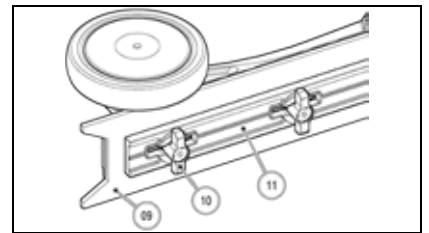

14. Rotate into position so that the edges in contact with the ground are not worn and insert into the squeegee body.
15. Insert the rubber-pressing blades (11) and turn the wing nuts (10) into vertical position so they hold the rubber-pressing blades against the squeegee body.

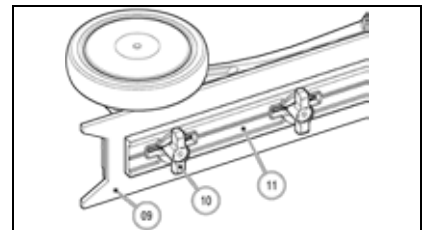

16. Tighten the knobs (12) that fix the vacuum nozzle (06) to the squeegee body.
17. First with a jet of water and then with a damp cloth, thoroughly clean the vacuum nozzle (06). Also clean the squeegee body support surface.
18. Position the vacuum nozzle (06) on the squeegee body and fasten with the knobs (12).

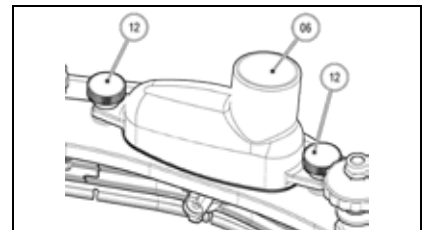



## WEEKLY MAINTENANCE

### 44. CLEANING THE VACUUM HOSE

Whenever vacuum seems to be unsatisfactory, check that the vacuum hose is not obstructed. If necessary clean with a jet of water as follows:

1. Switch off the power supply to the machine's electrical system using the main switch (01) located on the rear of the machine, turning the key to position "0" (valid for versions BB).
1. Switch off the power supply to the machine's electrical system using the main switch (01) located on the rear of the machine, turning the key to position "0" (valid for versions B-BT).
2. Make sure the recovery tank is empty, otherwise empty it completely.
3. Disconnect the electrical connector (02) from the battery connector.
4. Engage the parking brake by means of the lever (03) on the right side of the machine (only for BT versions).
5. Remove the squeegee vacuum hose (04) from the hole in the recovery tank.
6. Remove the vacuum hose (04) from the vacuum nozzle (05) on the squeegee body.
7. Clean the vacuum hose (04) under a jet of running water.
8. Reassemble all the elements.

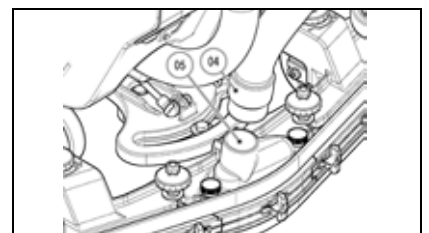
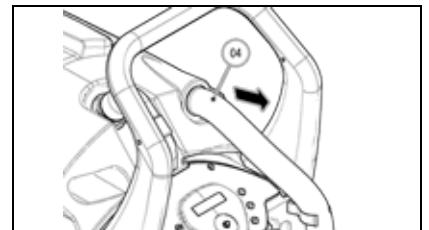
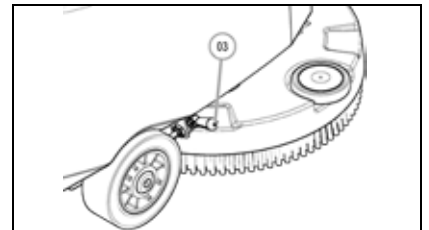
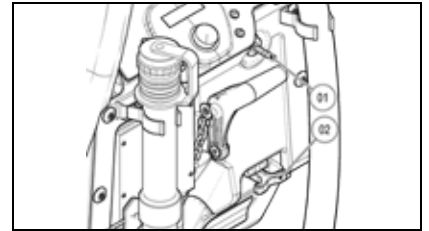
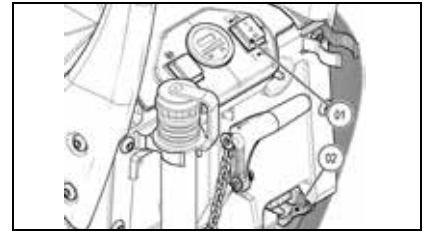

**WARNING:** This operation must be carried out using gloves to protect against contact with dangerous solutions.

### 45. CLEANING THE RECOVERY TANK

To avoid deterioration of the recovery tank and to prevent odours forming, weekly of the tank is recommended, proceeding as follows:

1. Switch off the power supply to the machine's electrical system using the main switch (01) located on the rear of the machine, turning the key to position "0" (valid for versions BB).

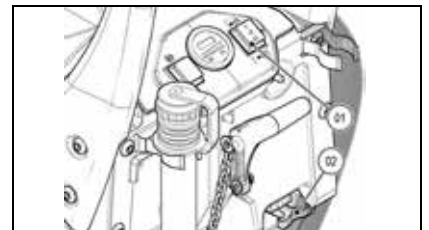



## WEEKLY MAINTENANCE

1. Switch off the power supply to the machine's electrical system using the main switch (01) located on the rear of the machine, turning the key to position "0" (valid for versions B-BT).
2. Make sure the recovery tank is empty, otherwise empty it completely.
3. Disconnect the electrical connector (02) from the battery connector.

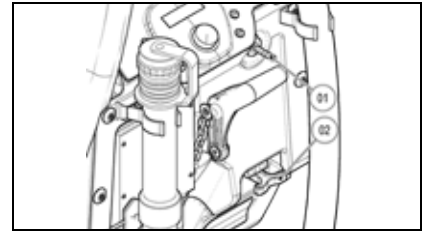

4. Engage the parking brake by means of the lever (03) on the right side of the machine (only for BT versions).

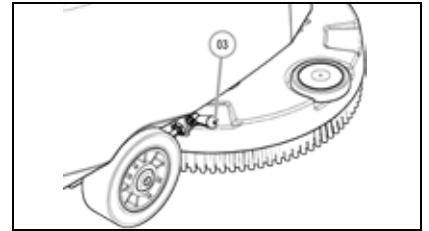

5. Remove the squeegee body vacuum hose (04) from the hole in the recovery tank.



**WARNING:** This operation must be carried out using gloves to protect against contact with dangerous solutions.

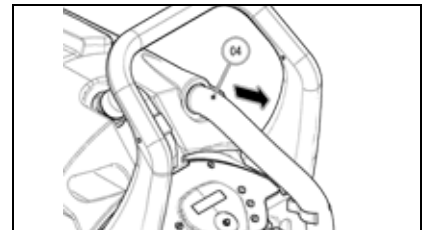

6. Disconnect the vacuum motor hose (05) from the squeegee nozzle on the recovery tank.

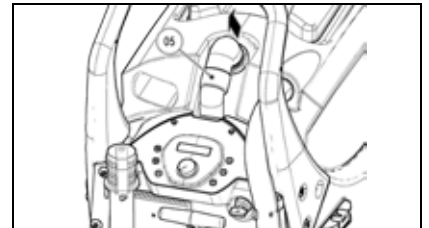

7. Remove the recovery tank drainage hose (06) from the support and lay on the ground.

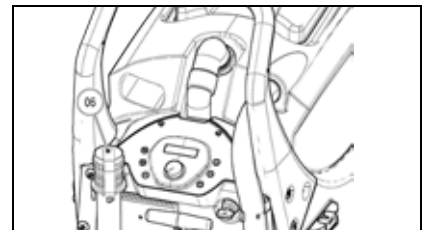

8. Remove the vacuum cover (07) and position on the support (08) designed for this purpose, positioned at the rear of the machine.



**WARNING:** To use the support (08), simply turn the tongue outwards, and once the support function is complete, the tongue can be turned back inwards.

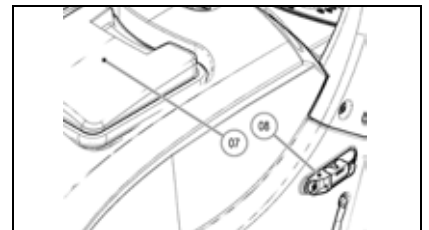





## WEEKLY MAINTENANCE

9. Turn the cup (09) anticlockwise and remove from the machine.
10. Remove the recovery tank filter (10).
11. Remove the recovery tank from the machine, taking extra care with the drainage hose.
12. Open the recovery tank drainage tube cap (06).
13. Take the machine to the designated place for draining off the dirty water and clean under a jet of running water, remembering to also clean the insertion nozzle on squeegee body vacuum tube (04) and the vacuum motor tube (05) carefully.
14. Reassemble all the elements.

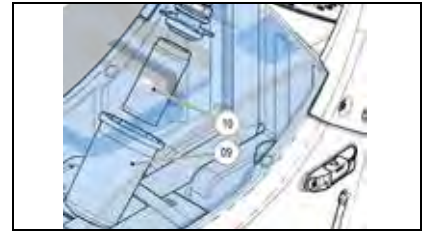

### 46. CLEANING THE SOLUTION TANK

To avoid deterioration of the solution tank and to prevent odours forming, weekly clean of the tank is recommended, proceeding as follows:

1. Switch off the power supply to the machine's electrical system using the main switch (01) located on the rear of the machine, turning the key to position "0" (valid for versions BB).

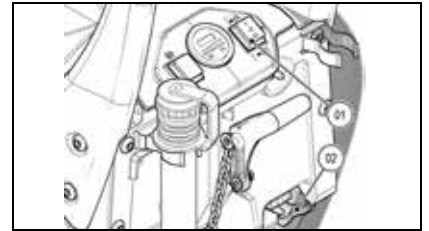

1. Switch off the power supply to the machine's electrical system using the main switch (01) located on the rear of the machine, turning the key to position "0" (valid for versions B-BT).
2. Make sure the recovery tank is empty, otherwise empty it completely.
3. Disconnect the electrical connector (02) from the battery connector.

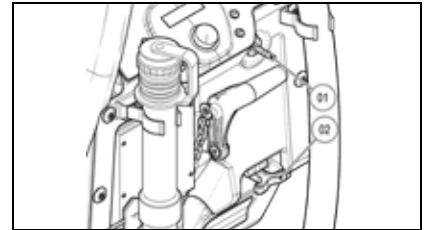

4. Engage the parking brake by means of the lever (03) on the right side of the machine (only for BT versions).

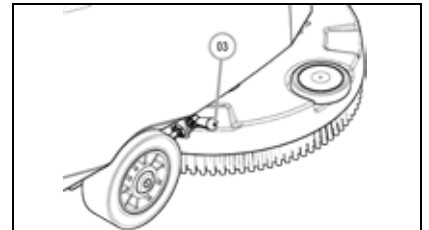

5. Loosen the solution tank filter cap (04), turning it anticlockwise.



**WARNING:** This operation must be carried out using gloves to protect against contact with dangerous solutions.

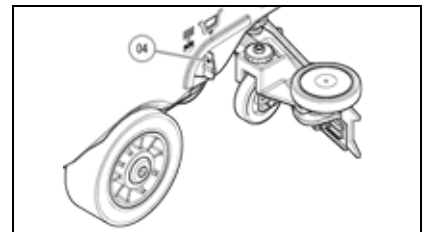

6. Remove the filler cap (05) from the solution tank.



7. Remove the quick fill tube (06) from the solution tank.
8. Remove the cover (07) from the quick fill tube and clean under a jet of running water.
9. Rinse the solution tank with a jet of running water.
10. Reassemble all the elements.





## EMERGENCY MAINTENANCE

### 47. ADJUSTING THE PARKING BRAKE (ONLY FOR BT VERSIONS)

To avoid damage to the machine or to persons or objects nearby when placing the machine in rest mode, users are advised to check the condition of the parking brake, proceeding as follows:

1. Switch off the power supply to the machine's electrical system using the main switch (01) located on the rear of the machine, turning the key to position "0" (valid for versions B-BT).
2. Disconnect the electrical connector (02) from the battery connector.
3. Check the distance between the parking brake pad (03) and the wheel - in rest mode, the maximum distance should not exceed 3 mm.
4. If adjustment of the parking brake is necessary, loosen the lock nut (04) and tighten or loosen the pad (03).
5. Once adjustment is complete, re tighten the lock nut (04).

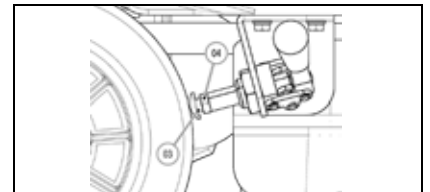
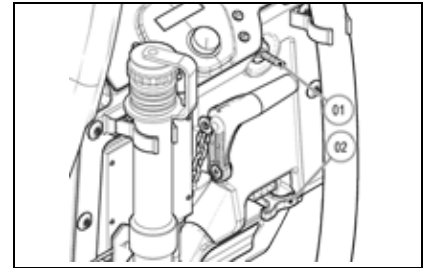

### 48. BRUSH REPLACEMENT (B-BT VERSIONS)

An undamaged brush ensures a better working capacity, to replace it proceed as follows:

1. Make sure the recovery tank is empty, otherwise empty it completely.
2. Check that the squeegee body is raised above the ground; if not, lift using the lever (01) on the rear of the machine.
3. Engage the parking brake by means of the lever (02) on the right side of the machine (only for BT versions).
4. Put the machine in rest mode. Using the control handlebar (pushing downwards), lift the front part of the machine so that the rear wheel rests on the floor.
5. Press the brush release button (03) on the instrument control panel. As soon as the button is pressed, you will see the question "RELEASE?" on the screen. Press the brush release button (03) on the steering wheel again, to confirm.
6. Remove the old brush and replace with the new, reading the paragraph "ASSEMBLING THE BRUSH" before carry out the replacement.

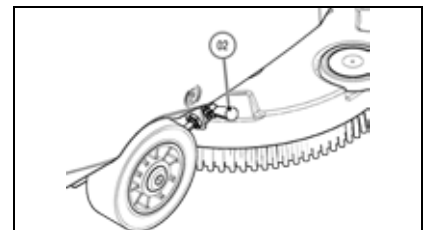
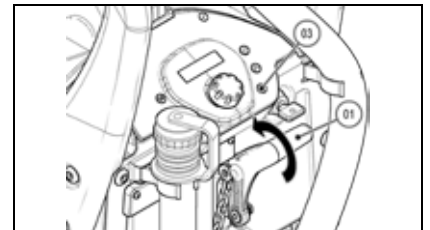

**WARNING:** If the brush does not release, repeat the operation again until the brush is released from the brush head.

**WARNING:** During this operation, check there are no people or objects near the brush.

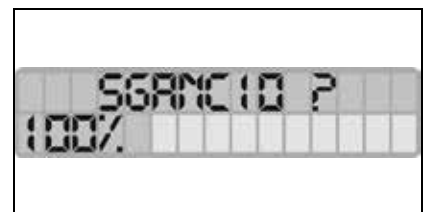

### 49. BRUSH REPLACEMENT (BB VERSIONS)

An undamaged brush ensures a better working capacity, to replace it proceed as follows:

1. Make sure the recovery tank is empty, otherwise empty it completely.
2. Check that the squeegee body is raised above the ground; if not, lift using the lever (01) on the rear of the machine.



## EMERGENCY MAINTENANCE

3. Make sure that the main switch (02) is in the "II" position; if not, position it to "II".
4. Put the machine in rest mode. Using the control handlebar (pushing downwards), lift the front part of the machine so that the rear wheel rests on the floor.
5. Press the dead man's lever under the control handlebar and simultaneously activate the brush release lever (03) positioned at the rear of the machine. As soon as lever (03) is activated, release dead man's lever under the control handlebar.

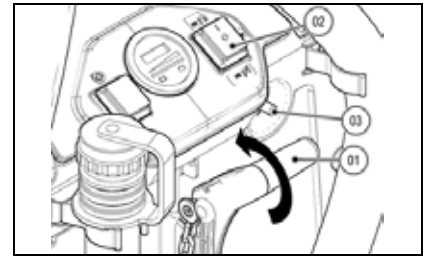

**WARNING:** If the brush does not release, repeat the operation again until the brush is released from the brush head.

**WARNING:** During this operation, check there are no people or objects near the brush.

6. Remove the old brush and replace with the new, reading the paragraph "ASSEMBLING THE BRUSH" before carry out the replacement.

### 50. REGULATING MACHINE DIRECTION

On the front of the machine, there is a knob (01) which allows users to adjust the direction of the machine. If the machine tends to veer to the right, the knob must be turned clockwise, whilst if the machine tends to veer to the left, the knob should be turned anticlockwise.



**WARNING:** Directional operation of the machine should be carried out with the brush mounted and with a light flow of solution in order to avoid damage to the floor.

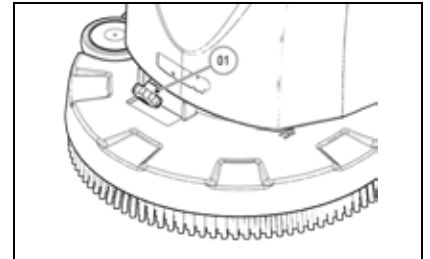

### 51. REPLACING SQUEEGEE BODY RUBBERS

The careful cleaning of the whole vacuum unit ensures better drying and cleaning of the floor as well as greater duration of the vacuum motor.

To detach the squeegee body from its support, proceed as follows:

1. Switch off the power supply to the machine's electrical system using the main switch (01) located on the rear of the machine, turning the key to position "0" (valid for versions BB).
1. Switch off the power supply to the machine's electrical system using the main switch (01) located on the rear of the machine, turning the key to position "0" (valid for versions B-BT).
2. Disconnect the electrical connector (02) from the battery connector.
3. Engage the parking brake by means of the lever (03) on the right side of the machine (only for BT versions).
4. Lower the squeegee body by means of the lever (04) on the back of the machine.

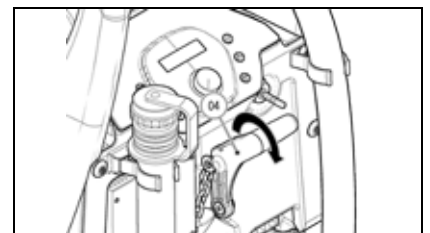
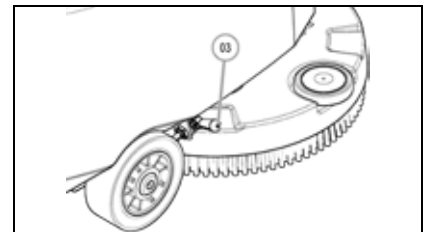
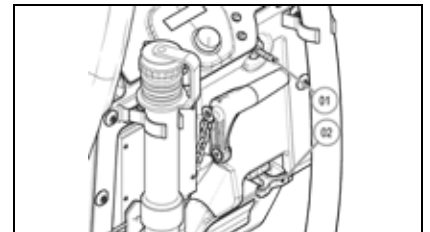



## EMERGENCY MAINTENANCE

5. Remove the vacuum hose (05) from the vacuum nozzle (06) on the squeegee body.
6. Loosen the knobs (07) in the squeegee body pre-assembly.
7. Remove the squeegee body from the slits in the squeegee connector.



**WARNING:** This operation must be carried out using gloves to protect against contact with dangerous solutions.

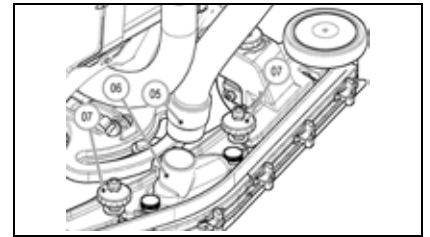

Proceed as follows for replacing the front rubber blade of the squeegee body:

1. Turn the wing nuts (08) in the horizontal position.
2. Remove the front rubber-pressing blades (09).
3. Remove the rubber (10) and replace it.
4. Proceed in reverse to replace the rubber.

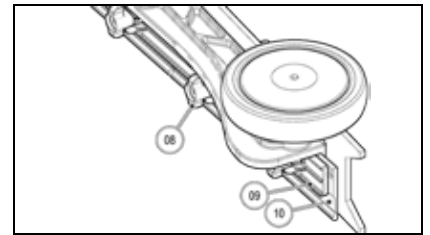

Proceed as follows for replacing the rear rubber blade of the squeegee body:

1. Turn the wing nuts (08) in the horizontal position.
2. Remove the front rubber-pressing blades (09).
3. Remove the rubber (10) and replace it.
4. Proceed in reverse to replace the rubber.

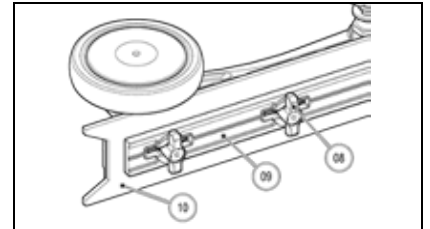

## 52. ADJUSTING THE SQUEEGEE INCLINATION

During working operation, the rear rubber blade is slightly tilted backwards (by about 5mm) in a uniform way for its whole length. If you need to increase the bend of the rubber in the central part, you must tilt the squeegee unit. To do this, proceed as follows:

1. Loosen the locknut (01)
2. Turn the screw (02) clockwise to increase the bend of the rubber in the central part of the squeegee.
3. When fully adjusted, fix the locknut (01)

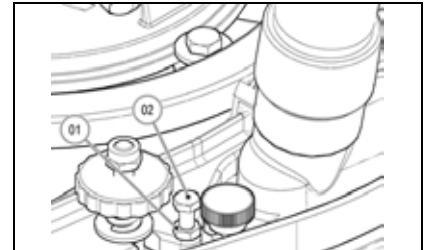

## 53. ADJUSTING THE SQUEEGEE HEIGHT

The height of the squeegee must be adjusted on the basis of the state of wear and tear of the rubber. To adjust the height, simply turn the knobs (01) on the squeegee support. To decrease the distance between the wheels and the floor simply follow the arrows with the sign "-", while to increase the distance just follow the arrows with the "+" sign.



**WARNING:** For effective drying, the wheels must be at the same distance from the floor.

**WARNING:** To facilitate the operation, completely lower the squeegee and put a spacer of a few millimetres (2 to 4 mm depending on the type of rubber) under the wheels.

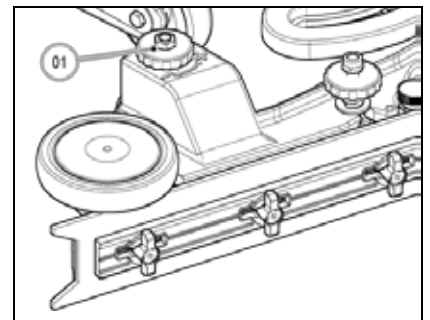



## TROUBLESHOOTING

### 54. THE MACHINE DOES NOT START

1. Check that batteries are charged
2. Make sure the electric system connector is connected to the battery connector
3. Check that the key switch is in position "I" (B-BT versions).

### 55. INSUFFICIENT WATER ON THE BRUSHES

1. Check there is water in the solution tank
2. Check that the detergent solution release adjustment knob (1) is open.

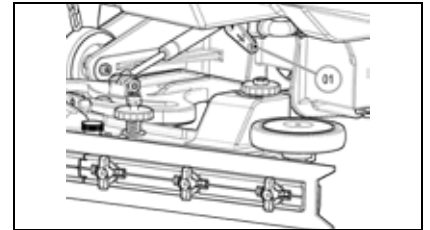

3. Clean the solution filter (02) located on the rear left part of the machine.

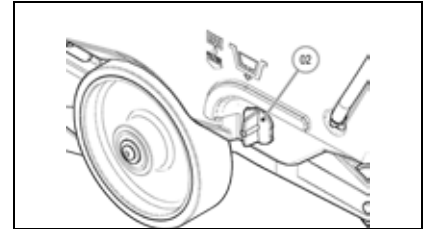

### 56. THE SQUEEGEE DOES NOT DRY PERFECTLY

1. Check the squeegee is clean
2. Check the squeegee adjustments (see "EMERGENCY MAINTENANCE").
3. Clean the entire vacuum unit (see "WEEKLY MAINTENANCE")
4. Replace the squeegee body rubbers, if worn.

### 57. THE MACHINE DOES NOT CLEAN WELL

1. Check the state of wear and tear of the brushes and, if necessary, replace them. The brushes should be changed when the bristles are about 15mm long. To replace these, see paragraph "BRUSH REPLACEMENT" in the chapter "EMERGENCY MAINTENANCE". Working with an over-worn brush may cause damage to the floor.
2. Use a different kind of brush to the one fitted as standard. For cleaning floors where the dirt is particularly resistant, we recommend the use of special brushes supplied upon request and according to needs (see chapter "CHOOSING AND USING THE BRUSHES").

### 58. EXCESSIVE FOAM PRODUCTION

Check that a low foam detergent has been used. If necessary, add a small quantity of antifoam liquid to the recovery tank.

Remember that, when the floor is not very dirty, more foam is generated. In this case the detergent solution should be more diluted.

### 59. THE VACUUM CLEANER DOES NOT FUNCTION

1. Check whether the recovery tank is full and, if necessary, empty it.
2. Check the correct operation of the float in the recovery tank (see also "CLEANING THE RECOVERY TANK FILTER" in the chapter "DAILY MAINTENANCE")

### 60. THE BRUSH MOTOR DOES NOT WORK

**WARNING** To avoid damaging the floor, the motor only starts up when the machine is moved forwards

1. Check that the brush head is in contact with the ground when moving forwards.
2. Check the motor is correctly connected to the machine's electrical system.



## DISPOSAL

To dispose of the machine, take it to a demolition centre or an authorised collection centre.

Before scrapping the machine it is necessary to remove and separate the following materials and send them to the appropriate collection centres in accordance with the environmental hygiene regulations currently in force:

- brushes
- felt
- electric and electronic parts\*
- batteries
- plastic parts (tanks and handlebars)
- metal parts (levers and frame)

(\*) In particular, to scrap the electric and electronic parts, contact your area distributor.



## CHOOSING AND USING THE BRUSHES

### POLYPROPYLENE BRUSH (PPL)

Used on all types of floor, it has good resistance to wear and tear and hot water (no greater than 60°C). PPL is non-hygroscopic and therefore retains its characteristics even when working in wet conditions.

### NYLON BRUSH

Used on all types of floors. Excellent resistance to wear and tear, and hot water (even over 60°C). The nylon is hygroscopic and so tends to lose its characteristics over time when working in wet conditions.

### ABRASIVE BRUSH

The bristles of this type of brush are charged with highly aggressive abrasives. It is used to clean very dirty floors. To avoid floor damage, work only with the pressure strictly necessary.

### THICKNESS OF THE BRISTLES

Thicker bristles are more rigid and are therefore used on smooth floors or floors with small joints.

On uneven floors or those with deep joints, it is advisable to use softer bristles which can enter the gaps more easily.

Remember that when the bristles are worn and therefore too short, they will become rigid and are no longer able to penetrate and clean deep down, also because, like with over-large bristles, the brush tends to jump.

### PAD HOLDER

The pad holder is recommended for cleaning shiny surfaces.

There are two types of pad holder:

1. The traditional pad holder is fitted with a series of anchor points that allow the abrasive floor pad to be held and dragged while working.
2. The CENTER LOCK type pad holder not only has anchor points, but also a snap-type central locking system in plastic that allows the abrasive floor pad to be perfectly centred and held without any risk of it becoming detached. This type of holder is especially suitable for machines with several brushes, where the centring of the abrasive floor pads is difficult.

TABLE FOR CHOOSING THE BRUSHES

Machine	No. of brushes.	Code	Type of bristles	ÆBristles	ÆBrush	Length	Notes
iMx	1	404654	PPL	0.3	495	-	BLUE BRUSH
		405631	PPL	0.6			WHITE BRUSH
		404653	PPL	0.9			BLACK BRUSH
		405632	ABRASIVE	1			BRUSH
		405527	-	-	500	-	PAD HOLDER



## EC DECLARATION OF CONFORMITY

The undersigned manufacturer:  
**FIMAP S.p.A.**  
Via Invalidi del Lavoro, 1  
37050 Santa Maria di Zevio (VR)  
declares under its sole responsibility that the product

**SCRUBBING MACHINES**  
**mod. iMx 50 B - iMx 50 BT - iMx 50 BB**

complies with the requirements of the following Directives:

- 2006/42/EC: Machinery Directive.
- 2006/95/EC: Low Voltage Directive.
- 2004/108/EC: Electromagnetic Compatibility Directive.

They also comply with the following standards:

- EN 60335-1: Household and similar electrical appliances - Safety. Part 1: Generic standards.
- EN 60335-2-72: Household and similar electrical appliances. Part 2: Generic standards for automatic machines for floor treatment for commercial and industrial use.
- EN 60335-2-29: Household and similar electrical appliances. Part 2: Special standards for battery chargers.
- EN 12100-1: Machine safety - Fundamental concepts, fundamental principles of design - Part 1: Basic terminology and methodology.
- EN 12100-2: Machine safety - Fundamental concepts, fundamental principles of design - Part 2: Technical principles.
- EN 61000-6-2: Electromagnetic compatibility (EMC) - Part 6-2: Generic standards – Immunity for industrial environments.
- EN 61000-6-3: Electromagnetic compatibility (EMC) - Part 6-3: Generic standards — Standard emission for residential, commercial and light-industrial environments.
- EN 61000-3-2: Electromagnetic compatibility (EMC) - Part 3-2: Limits – Limits for harmonic current emissions (Equipment with input current ≤ 16 A per phase).
- EN 61000-3-3: Electromagnetic compatibility (EMC) - Part 3-3: Limits – Restriction of voltage variations and flicker in low voltage power supply systems for devices with a rated current ≤ 16 A.
- EN 55014-1: Electromagnetic compatibility - Regulations for household appliances, electrical devices and similar equipment. Part 1: Emission - Regulation for product family.
- EN 55014-2: Electromagnetic compatibility - Regulations for household appliances, electrical devices and similar equipment. Part 2: Immunity - Regulation for product family.
- EN 62233: Household and similar electrical appliances - Electromagnetic fields Methods for evaluation and measurement.

The person authorised to compile the technical file:

Sig. Giancarlo Ruffo  
Via Invalidi del Lavoro, 1  
37050 Santa Maria di Zevio (VR) - ITALY

Santa Maria di Zevio, 03/06/2013

FIMAP S.p.A.  
Legal representative  
Giancarlo Ruffo

**FIMAP spa**  
Via Invalidi del Lavoro, 1 - 37050 S.Maria di Zevio (Verona) Italy  
Tel. +39 045 6060411 r.a. - Fax +39 045 6060417 - E-mail: [fimap@fimap.com](mailto:fimap@fimap.com) - [www.fimap.com](http://www.fimap.com)